

**Briton**  
**#1**  
door hardware choice



*Trade* Door Hardware

**ALLEGION™** 

**Make the reliable choice**  
**Make the #1 choice**

We are a leading global provider of products and services that make environments safe and secure without inhibiting access or working capability. Our Briton branded ranges of door controls and exit devices have earned an enviable reputation for performance and reliability. Through constant design and development we also help to meet the requirements of The Equality Act so that people with reduced mobility can enjoy ease of access to and within the built environment without compromising security.



This catalogue is an easy to use guide to our trade range of architectural hardware and entry level access control products. It encompasses our major brands of door closers, exit devices, door furniture, lockcases and cylinders.

If you need further details on any of the product lines you can download full specification brochures from our website or for technical queries you can telephone our Technical Helpline.

[www.allegion.co.uk](http://www.allegion.co.uk)

Technical Helpline on **0800 834 102**

		Pages
	<b>DOOR CONTROLS</b> Door closers - Electromagnetic closers - Floor springs	<b>4 - 35</b>
	<b>PANIC AND EMERGENCY EXIT HARDWARE</b> Panic bolts & latches - Emergency push pads	<b>36 - 59</b>
	<b>COMMERCIAL AND CONTRACT SECURITY</b> European lockcases	<b>60 - 77</b>
	<b>RESIDENTIAL SECURITY</b> Lever locks - UK cylinder locks - Latches - Bolts	<b>78 - 89</b>
	<b>NIGHTLATCHES</b> Nightlatches - Rim locks	<b>90 - 93</b>
	<b>LOCKING CYLINDERS</b> Euro profile - Oval profile - Rim cylinders	<b>94 - 105</b>
	<b>MOBILE SECURITY</b> Padlocks & Hasps	<b>106 - 111</b>
	<b>DOOR FURNITURE</b> Lever handles - Escutcheons - Pulls - Accessories	<b>112 - 125</b>
	<b>NYLON DESIGN SYSTEM</b> Lever furniture - Pulls - Accessories	<b>126 - 153</b>
	<b>ACCESS CONTROL</b> Mechanical and Electronic code locks - Electromagnetic locks - MobileKey system	<b>154 - 159</b>
	<b>POINT OF SALE</b> Merchandisers - Display boards - Counter mats	<b>160 - 163</b>
	<b>GLOSSARY OF TERMS</b>	<b>164 - 165</b>
	<b>FINISHES</b>	<b>166 - 167</b>

**CE Mark explained**



Door closers are an important link in the control of fire and smoke and their usage can help save lives.

From July 2013 it became a legal requirement for all products which are covered by a harmonised EN standard to be CE marked before they can be placed on the market.

For door closing devices, EN 1154 and EN 1155 became harmonised standards across Europe and are now the standards required in order to attain CE marking. Validation of the CE mark requires the production of a Declaration of Performance (DoP) by the manufacturer.

DoPs for all Briton door controls are available on our website at:

[www.britondops.co.uk](http://www.britondops.co.uk)

**Closer power (EN 1154)**

To determine which closer size you require use the table below. Many Briton closers have adjustable power which allows you to adjust the power to suit the situation.

EN Closer Size	Recommended Door Width - Max.	Door Weight
1	750mm	20kg
2	850mm	40kg
3	950mm	60kg
4	1100mm	80kg
5	1250mm	100kg
6	1400mm	120kg
7	1600mm	160kg

**Fire door applications**

For fire door applications a closer with power size 3 is a minimum requirement.

**The Equalities Act - disability legislation**



Legislation aimed at providing universal accessibility of buildings requires service providers to make "reasonable adjustments to the physical features of their premises to overcome barriers to access".

Approved Doc M of the Building Regulations and BS 8300 provide guidance in establishing recommended opening forces for door controls to assist less able users.

High efficiency Briton closers which are capable of meeting the required levels of opening and closing forces are marked with the "Wheelchair Symbol" but accurate installation, hinge friction, door seals and variable air pressure can all have a bearing on the opening resistance of the final doorset.

For doors which must also meet the stringent closing force requirements for fire door applications, it may be more appropriate to use electromagnetic hold open or swing free closers or a powered opening solution.

**Adjustable closing power - Template Adjustable**

The closing power is adjusted by varying the mounting position on the door/frame. Once fitted the power cannot be adjusted.

**Adjustable closing power - Spring Adjustable**

The closing power is adjusted by spring compression once the closer is installed. Power can be adjusted at any time and with much finer control.

**Adjustable closing speed**

Speed of closing is adjustable from 180° opening through to the final 15°.

**Adjustable latch action**

The speed of closing in the last 15° can be adjusted to overcome seals and latches.

**Backcheck**

In-built cushioning towards the end of the opening cycle to minimise the risk of personal injury and damage to adjacent walls.

**Delayed Action**

Delays the closing cycle to allow slow moving pedestrians to pass through unhindered by the closing door.

**Adjustable hold-open**

Mechanical and electro-magnetic hold-open variants are available to hold the door in the open position (see page 6).

**Fitting application guide**

Surface mounted overhead door closers are normally supplied with either a projecting arm and bracket (sometimes referred to as scissor arm) or with a slide arm and track (sometimes called track arm).

Projecting arm closers can generally be fixed in one of three ways depending on the door location and frame configuration. Most Briton door closers are supplied **Tri-packed** meaning that they contain the necessary brackets and fixings to enable them to be fitted in any of the applications below [1 - 3].

Slide arm or track arm closers can be door or transom mounted [4 - 5] on the push or pull side of the door but you will need to be aware which configuration you need before ordering.

**Standard Scissor Arm Applications**

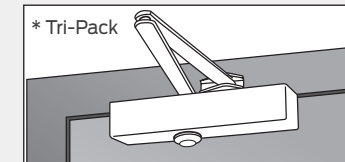

**1. Regular fixing**

Closer body mounted on the pull face of the door.

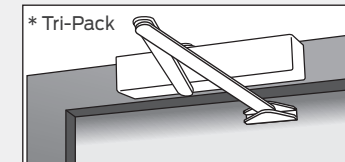

**2. Transom fixing**

Closer body mounted on the transom on the push side of the door.

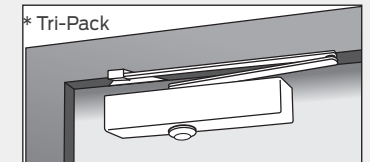

**3. Parallel fixing**

Closer body mounted on the push side of the door.

**Track Closer Applications**

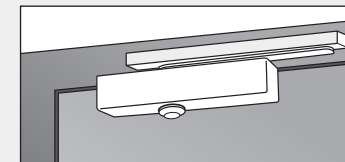

**4. Door mounted pull side**

Closer body mounted on the pull face of the door with slide track on the head frame. Most slide arm closers can also be mounted with the closer body on the head frame and the slide track on the door.

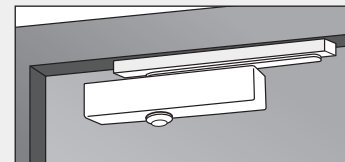

**5. Door mounted push side**

Closer body mounted on the push face of the door with slide track mounted on or under the head frame. Most slide arm closers can also be mounted with the closer body on the head frame and the slide track on the door.

**Mechanical hold-open unit**

Mechanical hold-open is achieved by substituting the standard armset with a hold-open armset (or a component concealed within the slide track). It enables doors to be securely held in the open position at a pre-set angle (adjustable on installation depending on model and the mounting application).

The hold-open facility can be easily overridden and the force required to release the hold-open action can be adjusted to suit the weight of door.

**Please note, mechanical hold-open is not permitted on fire door applications.**



**Electromagnetic hold-open or swing-free**

Electromagnetic hold-open or swing-free closers allow a door to be held open (or free to swing) in normal use but close under spring power in the event of a fire or power failure. This can be achieved using a closer which has an electromagnetic function integrated into the closer mechanism, or by using a separate electromagnetic holder in conjunction with a standard door closer. The electromagnet temporarily disables the spring mechanism which is automatically re-connected in the event of an alarm or power failure.

**Please note, electromagnetic hold-open or swing-free is permitted on fire door applications when connected into the building fire alarm or smoke detection system.**

**Briton Door Closers - Dimensions**

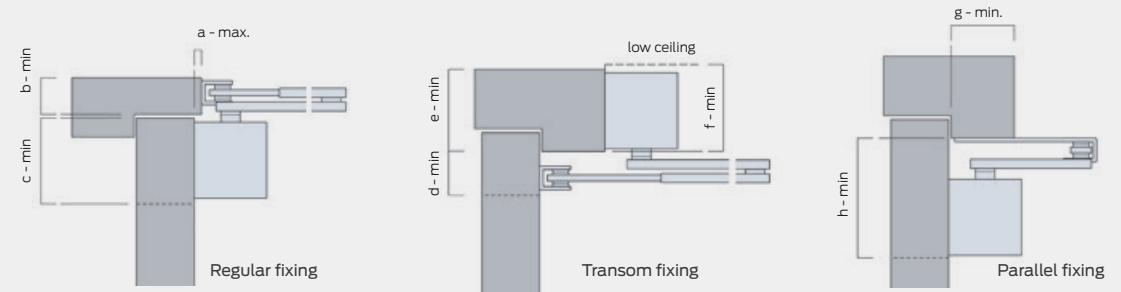

Closer	cover	dimensions (mm)							
		a	b	c	d	e	f	g	h
121CE	n/a	10	40 (40)	50	40 (40)	50	65	44	90 (110)
131	n/a	15	35	73	35	73	85	40	112
1110/1120B*	all	10	30 (30)	80	30 (43)	68	78	44	110 (123)
1130	all	10	35 (35)	80	30 (43)	75	75	44	110 (123)
2000 Series	C	10	25 (38)	50	28 (42)	50	68	44	88 (100)
2130B/2130BD	C	7	28 (41)	78	28 (42)	50	68	44	94 (107)

\* Maximum dimensions stated for cover versions.

Please note, the figures in brackets in the tables above are the dimensional variations when used with hold open armsets.

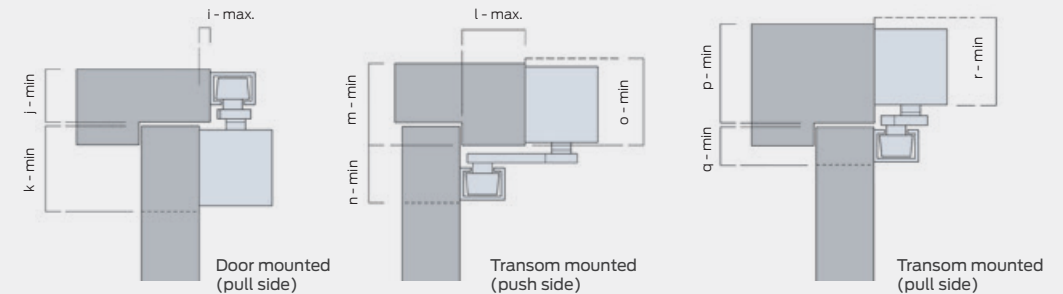

For details which are not shown please contact our customer care team on [0330 8080 617](tel:0330 8080 617)

Briton Door Controls Selector

General Description

The chart below lists the performance characteristics of each door control in respect of EN 1154. In addition it shows the mounting options, fire door applications and the primary functions for each, allowing you to make a preliminary selection of the most suitable product for your requirements.

- Feature as standard
- Available as an option
- CS - Cushion Stop facility

\* figures represent the Certifire Approved applications and the power sizes this covers.

		Overhead Door Closers												Overhead Door Closers		Electromagnetic Door Closers										Transom Closers & Floor Springs										
		Briton 121	Briton 121CE	Briton 131	Briton 1110	Briton 1120B	Briton 1130B	Briton 1130B.T	Briton 2003	Briton 2004	Briton 2003V	Briton 2003.T	Briton 2130B	Briton 2130BD	Briton 2130B.T	Briton 2320.T & 2321.T	Briton 2420B.T	Briton 2720BD.T	Briton 2721BD.T	Briton 1130B.TE	Briton 2130B.TE	Briton 2720BD.TE	Briton 2721BD.TE	Briton 9963/01	Briton 9963/66	Briton 9964/01	Briton 9964/66	Briton 9965/01	Briton 9965/66	Briton 3934	Briton 2803	Briton 2822	Briton 2823	Briton 2824		
EN 1154 Categories	Performance & Features																																			
	Category of Use	4	3	3	4	4	4	4	4	4	4	4	4	4	4	4	3	4	4	3	3	3	3	3	3	3	3	3	3	3	3	3	-	3	3	
	No. of Test Cycles	8	8	8	8	8	8	8	8	8	8	8	8	8	8	8	8	8	8	8	8	8	8	8	8	8	8	8	8	8	8	-	8	8		
	Door Mass/Size	3	2-4	2-4	2-4	2-6	2-4	3	4	1-4	3	2-6	2-6	2-4		2-4	2-4	2-5	2-5	3-4	3-4	3-5	3-5	3	3	4	4	5	5	3-4	-	3	4			
	Fire Behaviour	1	1	1	1	1	1	1	1	1	1	1	1	1	1	1	1	1	1	1	1	1	1	1	1	1	1	1	1	1	1	1	1	1	1	
	Safety	1	1	1	1	1	1	1	1	1	1	1	1	1	1	1	1	1	1	1	1	1	1	1	1	1	1	1	1	1	1	1	1	1	1	
	Corrosion Resistance	3	3	3	3	3	3	3	3	3	3	3	3	3	3	3	3	3	3	3	3	3	3	3	3	3	3	3	3	3	3	3	3	3	3	3
Regular Fixing (Power size)*	#2-4	#3	#2-4	#2-4	#2-4	#2-6	#2-4	#3	#4	#1-4	#3	#2-6	#2-6	#2-4	#2-4	#2-4	#2-5	#2-5	#3-4	#3-4	#3-5	#3-5	#3		#4		#5		#3-4	#2	#3	#4				
Transom Fixing (Power size)*	#2-4	#3	#2-4	#2-4	#2-4		#2-4	#3	#4	#1-4	#3	#2-6	#2-6		#2-4	#2-4	#2-4	#2-5					#3		#4		#5		#3-4							
Parallel Fixing (Power size)*	#2-4	#3	#3	#3	#3-4	#2-5	#2-4			#1-4		#2-5	#1-5											#3		#4		#5	#3							
Slide Track Mounted (Pull side)							■				■				■		■	■	■	■	■	■	■													
Slide Track Mounted (Push side)							■								■		■	■	■	■	■	■	■													
Concealed Door/Transom Mount																■																				
Timber fire doors up to	-	2 hr	2 hr	2 hr	2 hr	2 hr	2 hr	2 hr	2 hr	2 hr	2 hr	2 hr	2 hr	2 hr	2 hr	2 hr	1 hr	2 hr	2 hr	2 hr	2 hr	2 hr	2 hr	2 hr	2 hr	2 hr	2 hr	2 hr	2 hr	2 hr	2 hr	2 hr	2 hr	2 hr	2 hr	
Steel fire doors up to	-		4 hr	4 hr	4 hr	4 hr	4 hr	4 hr	4 hr	4 hr	4 hr	1 hr	1 hr	1 hr			1 hr	1 hr		4 hr	1 hr	1 hr														
Certifire Approval (Cert. No.)	-	390	5512	388	388	388	388	111	111	111	111	111	111	111	5291		738	738	388	111	738	738	109	109	109	109	109	109	109	109	109	109	5598			
Adjustable Power	■		■	■	■	■	■			■		■	■	■	■	■	■	■	■	■	■	■	■							■	■					
Adjustable Closing Speed	■	■	■	■	■	■	■	■	■	■	■	■	■	■	■	■	■	■	■	■	■	■	■	■	■	■	■	■	■	■	■	■	■	■	■	■
Backcheck Facility					■	■	■			■		■	■	■	■	CS	■	■	■	■	■	■	■													
Delayed Action														■									■	■												
Mechanical Hold-Open	□		□			□		□	□	□	□	□	□	□	□	□	□	□																□	□	□
Electro-mechanical Hold-Open																					■	■	■	■	■	■	■	■	■	■	■	■	■	■	■	■
Electro-mechanical Swing Free																								■	■	■	■	■	■	■	■	■	■	■	■	■

Briton 121CE

Overhead Door Closer



General Description

A compact, template adjustable or fixed power closer suitable for light to medium duty applications. This cost effective closer exhibits the characteristics of performance, durability and quality that you expect from a Briton door closer, and is certified in all applications and easy to install.

Principal Features

- Clear installation instructions
- Fitting template for quick, accurate installation
- Universal fittings for regular, transom or parallel mount fitting
- Smooth, quiet operation
- Adjustable closing speed & latch action
- Optional hold open armset available (NOT TO BE USED ON FIRE DOORS)

- Testing: EN 1154 and CE Marked EN 1634 for up to 2 hour timber fire door
- Certifire Approved CF390
- Guarantee: 10 years



Finishes

Available in a choice of sprayed finishes (see page 167 for full details).

Certifire

Approval covers EN 3 in regular, transom and parallel applications.

PLEASE NOTE: Testing & Certification applies to 121CE model only

Item Ref:	Description	EN Power Size	Finishes
121CE	Closer with screw thread armset	Fixed power size 3	SES; GES; BES; WHS
121	Template adjustable closer EN 2-4 (non CE variant available for non fire door)	Adjustable size 2-4	SES; GES; BES; WHS
121.APH	Hold open arm pack for Briton 121 only		SES; GES; BES; WHS
121.BRK.66.BE	Parallel mounting bracket for Briton 121		Black

Briton 131

Overhead Door Closer



General Description

The Briton 131 offers a compact, template adjustable power closer which is suitable for most door sizes. With a simple, no nonsense installation, the closer comes with a screwthread armset and brackets certified for regular and parallel mount applications.

Principal Features

- Template adjustable closing power EN 2-4 in regular mounting EN 3 in parallel mounting EN 3 in transom mounting (Not CE marked)
- Clear installation instructions
- Fitting template for quick and accurate installation
- Universal fixings to allow for Regular, Transom or Parallel mount fitting
- Certified for Regular and Parallel mount applications
- Smooth, quiet operation
- Adjustable closing speed and latch action
- Suitable for fire door applications
- Optional hold-open arm pack available

- Testing: EN 1154 and CE Marked EN 1634 for up to 2 hr timber & 4 hr steel fire doors
- Certifire Approved
- Guarantee: 10 years



Finishes

Available in SES finish. (see page 167 for full details).

Item Ref:	Description	EN Power Size	Finishes
131	Closer with screw thread armset	Template adjustable EN 2-4	SES
131.APH	Hold-open arm pack	n/a	SES

Briton 1100 Series

Overhead Door Closers

Briton 1110

Template Adjustable Closer



Briton 1110 with Trimplate cover in SES finish

Briton 1110.C with Classic cover in SSS finish

Briton 1110.S with Softline cover in SSS finish

General Description

A comprehensive range of fixed strength and adjustable power overhead door closers available with simple trimplate cover or two optional all-over covers to conceal fixings and adjustment screws.

Principal Features

- Clear installation instructions
- Fitting template for quick and accurate installation
- Universal fixings to allow for Regular, Transom or Parallel mount fitting
- Good value for money
- Smooth, quiet operation
- Suitable for fire door applications
- Trimplate offers a simple, cost effective means of concealing fixing & adjustment screws reducing the risk of vandalism and tampering

- Testing: EN 1154 and CE Marked EN 1634 for up to 2 hour timber fire door and up to 4 hour steel fire door

- Certifire Approved CF388
- Guarantee: 10 years



\*\* 1 hour rating for all cover options

Finishes

Available in a choice of sprayed finishes and plated metallic finishes all with matching arms and brackets/track. (see page 167 for full details).

Certifire

Approval covers EN 2 - 4 (regular & transom), EN 3 (parallel applications)

\*\* Classic and Softline covers certified 1hr only on steel doors



\*\* 1 hour rating for all cover options

Item Ref:	Description	EN Power Size	Finishes
1110	Closer with Trimplate cover and screw thread armset	Template adjustable size 2 - 4	SES
1110.C**	Closer with all over Classic cover and flat form armset	Template adjustable size 2 - 4	SES; SSS
1110.S**	Closer with all over Softline cover and flat form armset	Template adjustable size 2 - 4	

Briton 1120B

Spring Adjustable Closer

Additional Features

- Adjustable backcheck
- Capable of meeting BS8300 requirements

Certifire

Approval covers EN 2 - 4 (regular & transom), EN 3 - 4 (parallel applications)

\*\* Classic and Softline covers certified 1hr only on steel doors



\*\* 1 hour rating for all cover options

Item Ref:	Description	EN Power Size	Finishes
1120B	Closer with backcheck, Trimplate & screw thread armset	Spring power adjustable size 2 - 4	SES
1120B.C**	Closer with backcheck, Classic cover & flat form armset	Spring power adjustable size 2 - 4	SES; SSS
1120B.S**	Closer with backcheck, Softline cover & flat form armset	Spring power adjustable size 2 - 4	

Briton 1130B

Spring Adjustable Closer

Additional Features

- Adjustable backcheck
- Capable of meeting BS8300 requirements

Certifire

Approval covers EN 2 - 6 in regular and EN 2 - 5 in parallel applications

\*\* Classic and Softline covers certified 1hr only on steel doors



\*\* 1 hour rating for all cover options

Item Ref:	Description	EN Power Size	Finishes
1130B	Closer with backcheck, Trimplate & screw thread armset	Spring power adjustable size 2 - 6	SES
1130B.C**	Closer with backcheck, Classic cover & flat form armset	Spring power adjustable size 2 - 6	SES; SSS
1130B.S**	Closer with backcheck, Softline cover & flat form armset	Spring power adjustable size 2 - 6	

Briton 1130B.T

Slide Track Closer

General Description

A Briton 1100 Series closer with slide track.

Briton 1130B.T.S with Softline cover in SS finish



Certifire

1130B.T Approval covers EN 2 - 4 in regular & transom applications

Principal Features

- Slide track application eliminates the projecting arm and is ideal for areas which may be subject to abuse
- Testing: EN 1154 and CE Marked EN 1634 for up to 2 hour timber fire door and up to 4 hour steel fire door
- Certifire Approved CF388
- Guarantee: 10 years



\*\* 1 hour rating for all cover options

Item Ref:	Description	EN Power Size	Finishes
1130B.T	Closer with Trimplate cover and slide track	Spring adjustable power size 2 - 4	SES
1130B.T.C**	Closer with all over Classic cover and slide track	Spring adjustable power size 2 - 4	SES; SSS
1130B.T.S**	Closer with all over Softline cover and slide track	Spring adjustable power size 2 - 4	



Briton 1130B.TE

Electromagnetic Hold-Open Closer

General Description

Linked to the building's alarm system, electromagnetic door controls eliminate the illegal practice of wedging doors open. This dangerous practice prevents a fire door functioning as it should in stopping the spread of flames and smoke in the event of a fire.

This option also offers a means of providing access through doors which might otherwise be difficult for elderly or disabled users to negotiate.

Briton 1130B.TE with trimplate cover in SES finish



Briton 1130B.TE.S with Softline cover in SES finish

Certifire

Approval covers EN 3 - 4 in regular applications only

Principal Features

- Fully certified to EN 1154 and EN 1155
- Designed for use on low voltage circuits 24V DC linked to a fire alarm
- Electromagnetic Hold-Open function
- Adjustable backcheck
- On-board test switch simulates fire alarm status
- Testing: EN 1154, EN 1155 and CE Marked  
EN 1634 fire testing for:  
2 hour timber fire doors  
4 hour steel fire doors
- Certifire Approved
- Guarantee: 10 years mechanical  
2 years electrical



Finishes

Available in a choice of sprayed finishes and plated metallic finishes all with matching arm and track.

Functions

**Hold Open.** In hold open operation, the door can be kept in an open position. When reactivated by alarm activation, the hold open mechanism is released and the door is closed under the spring power of the closer.

Item Ref:	Description	EN Power Size	Finishes
1130B.TE	Electromagnetic hold open closer with Trimplate	Spring power adjustable size 3 - 4	SES;
1130B.TE.S	Electromagnetic hold open closer with Softline cover	Spring power adjustable size 3 - 4	SES; SSS

Briton 2000 Series

Overhead Door Closers

General Description

The nations most popular range of fixed strength and adjustable power overhead door closers. Certified in all applications, reliable and easy to install.

Often imitated, but never bettered.



Briton 2003V in SES finish



Principal Features

- Clear installation instructions
- Accufit self-adhesive template for quick and accurate installation
- Easy to adjust
- Adjustable power, closing speed and backcheck for the perfect closing action
- Universal fixings to allow for Regular and Parallel mount fitting
- Smooth, quiet operation
- Suitable for fire door applications
- Testing: EN 1154 and CE Marked  
EN 1634 fire testing for:  
2 hour timber fire doors  
4 hour steel fire doors
- Certifire Approved CF111
- Guarantee: 10 years



Finishes

Available in a wide range of finishes, all with matching arms and brackets/track. Finishes include sprayed finishes, solid metallic finishes. Powder coated coloured finishes to match the Normbau colour range are available to order.

(see page 167 for full details).

Options

- Finishes (see above)
- Hold open armset available (NOT TO BE USED ON FIRE DOORS)

Briton 2003 & 2004 Fixed Power Closers

Certifire

Approval covers regular; & transom applications only



Item Ref:	Description	EN Power Size	Finishes
2003	Closer with Square cover and flat form armset	Fixed power size 3	SES; SSS
2004	Closer with Square cover and flat form armset	Fixed power size 4	

Hold open armsets also available for non fire doors.

Briton 2003V Spring Adjustable Closer

Briton 2003V with classic cover in SSS finish with matching arm and bracket



Additional Features

- Adjustable backcheck
- Capable of meeting BS8300 requirements



**OUTSTANDING PERFORMANCE**  
THE BRITON 2003V HAS BEEN IN-HOUSE TESTED TO OVER 1 MILLION CYCLES.

Certifire

Approval covers regular; transom & parallel applications

Item Ref:	Description	EN Power Size	Finishes
2003V	Closer with backcheck, Square cover and flat form armset	Spring power adjustable size 1 - 4	SES; SSS

Hold open armsets also available for non fire doors.

Briton 2000 Series

Accessories



Mechanical hold-open armset

Item Ref:	Description	Finishes
2000.AP	Arm pack for Briton 2000 Series	SES; SSS
2000.APH	Hold-open arm pack for Briton 2000 Series	SES; SSS
2003V.AP	Arm pack for Briton 2003V	SE; SS
2003V.APH	Hold-open arm pack for Briton 2003V	SE; SS
2003V.BP	Backplate pack	n/a
2003V.BRK66	Fig. 66 bracket pack	SE; SS; BM
2003V.FP	Fixing pack	SV

Briton 2100 Series

Overhead Door Closers

General Description

The ideal choice for high traffic areas, the Briton 2100 Series of door controls provides a multi-level door closing solution to suit all projects, door applications and budgets.

Principal Features

- Clear installation instructions
- Accufit self-adhesive template for quick and accurate installation
- Adjustable closing speed and latch action
- Backcheck capability to offer resistance against excessive force used in opening the door
- Universal fixings to allow for Regular, Transom or Parallel mount fitting
- Suitable for fire door applications
- Certified for door, frame mount and parallel arm applications

- Testing: EN 1154 and CE Marked EN 1634 fire testing for:  
2 hour timber fire doors  
1 hour steel fire doors

- Certifire Approved CF111 (except 2130BD)
- Guarantee: 10 years



Finishes

Available in a wide range of finishes, all with matching arms and brackets/track.

Finishes include sprayed finishes, solid metallic finishes. Powder coated coloured finishes to match the Normbau colour range are available for 2130B & 2130BD (see page 167 for full details).

Options

- Hold open armset available to order (NOT TO BE USED ON FIRE DOORS)

\* Delayed action is not covered by CE marking or Certifire Approval



Briton 2130B with C Cover in SES finish

Briton 2130B

Spring Adjustable Closer

Certifire

Approval covers EN 2 - 6 in regular & transom and EN 1 - 5 in parallel applications

Additional Features

- Adjustable backcheck
- Capable of meeting BS8300 requirements



Item Ref:	Description	EN Power Size	Finishes
2130B.C	Closer with backcheck, C style cover and flat form armset	Spring power adjustable size 2 - 6	SES; SSS

Hold open armsets also available for non fire doors.  
Hold open door closers also available.

Briton 2130BD

Spring Adjustable with Delayed Action

Additional Features

- Adjustable backcheck
- Adjustable delayed action



Item Ref:	Description	EN Power Size	Finishes
2130BD.C	Closer with backcheck, delayed action*, C style cover and flat form armset	Spring power adjustable size 2 - 6	SES; SSS

Briton 2130B.T

Slide Track Closer

Additional Features

- Adjustable backcheck
- Adjustable and fixed power options
- Slide track application



Briton 2130B.T.C with SSS finish



Certifire

2130B.T Approval covers EN 2 - 4 in Regular applications only

Item Ref:	Description	EN Power Size	Finishes
2130B.T.C	Closer with backcheck, C style cover & slide track	Spring power adjustable size 2 - 4	SES; SSS

Briton 2130B.TE

Electromagnetic Hold Open Closer



Briton 2130B.TE with Classic cover in SSS finish

General Description

Linked to the building's alarm system, electromagnetic door controls eliminate the illegal practice of wedging doors open. This dangerous practice prevents a fire door functioning as it should in stopping the spread of flames and smoke in the event of a fire.

This option also offers a means of providing access through doors which might otherwise be difficult for elderly or disabled users to negotiate.

Functions

**Hold Open.** In hold open operation, the door can be kept in an open position. When reactivated by alarm activation, the hold open mechanism is released and the door is closed under the spring power of the closer.

Principal Features

- CE Marked and fully certified to EN 1154 and EN 1155
- Designed for use on low voltage circuits 24V DC linked to a fire alarm
- Electromagnetic hold-open
- Adjustable backcheck
- On-board test switch simulates fire alarm
- Capable of meeting BS8300 requirements

- Testing: EN 1154, EN 1155 and CE Marked  
EN 1634 fire testing for:  
2 hour timber fire doors  
4 hour steel fire doors  
\*(for Briton 2130B.TE and 1130B.TE only)
- Certifire Approved CF111
- Guarantee: 10 years mechanical  
2 years electrical



Certifire

Approval covers EN 3 - 4 in regular applications only

Item Ref:	Description	EN Power Size	Finishes
2130B.TE.C	Electromagnetic hold open closer with Classic cover	Spring power adjustable size 3 - 4	SES; SSS

Briton 2300 Series

Adjustable Power Cam Action Closers

General Description

The Briton 2300 Series is offered as a simplified version of the Briton 2700 and is available with either a slide in trimplate or with a curved 'Softline' all-over cover which will suite with other Briton overhead door controls.

Principal Features

- CE Marked (AD5118)
  - High efficiency cam action technology
  - Simple to install using the unique Accufit installation system
  - Capable of meeting BS8300 requirements for use on accessible routes
  - Radiused trimplate cover conceals fixings and adjustment screws
  - Optional all over Softline cover to suite with other Briton closers
  - Fully adjustable for closing speed, latch action and backcheck
  - Optional hold-open kit
- 
- Testing: EN 1154 and CE Marked  
EN 1634 fire testing for:  
2 hour timber fire doors
  - Certifire Approved (CF5291)
  - Guarantee: 10 years



Finishes

Available in a range of sprayed finishes, solid or plated metallic finishes. (see page 167 for details)



Briton 2320B.T.S with Softline Cover Option in SS finish

Briton 2320B.T with trimplate in SES finish

Briton 2300 Series

Adjustable Power Cam Action Closers

Item Ref:	Description	Mounting Position	Finishes
2320B.T	Closer with backcheck, Trimplate cover - adjustable power size 2 - 4	Pull side of door or push side transom	SES; SSS; PSS
2321B.T	Closer with backcheck, Trimplate cover - adjustable power size 2 - 4	Push side of door or pull side transom	
2320B.T.S	Closer with backcheck, all-over Softline cover - adjustable power size 2 - 4	Pull side of door or push side transom	SES; SSS; PSS
2321B.T.S	Closer with backcheck, all-over Softline cover - adjustable power size 2 - 4	Push side of door or pull side transom	
2327.CS	Cusion stop mounted in track	Track mounted option	n/a
2320.HP	Hold open conversion kit for slide track	n/a	n/a
1502097	Mounting plate for pull side frame projection up to 16mm, push side up to 26mm	n/a	n/a

Briton 2320B.T - door mounted pull side

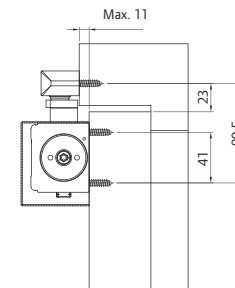

Briton 2321B.T - door mounted push side

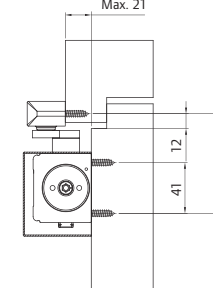

Briton 2321B.T - transom mounted pull side

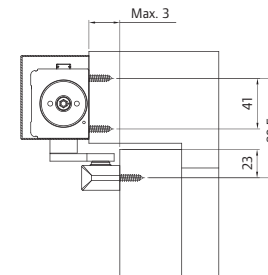

Briton 2320B.T - transom mounted push side

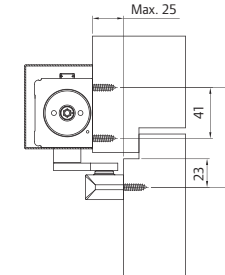

Cushion stop

Optional cushion stop (ref: 2327.CS) helps prevent doors from coming into contact with adjacent walls. It is installed within the slide track (note: this is not a backcheck function).



Briton 2400 Series

Concealed Cam Action Closer



Briton 2420.T - Door mounted orientation



Briton 2420.T - Transom mounted orientation

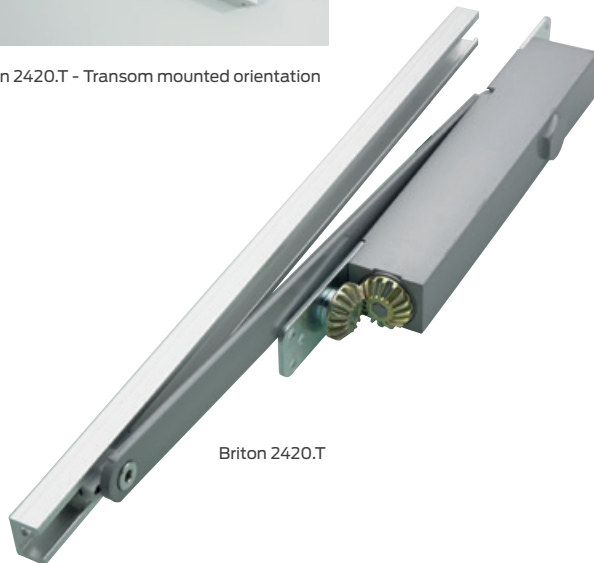

Briton 2420.T

General Description

The Briton 2400 Series is a precision manufactured cam-action, slide channel door closer, in a compact concealed unit. With the closer body mounted within the top of the door and the slide track within the head frame, the Briton 2400 Series offers high resistance to abuse and offers a highly aesthetic solution being fully concealed when the door is closed. Suitable for doors 44mm thick and above.

Principal Features

- CE Marked (AD5114)\*
  - High efficiency cam action technology
  - Capable of meeting BS8300 requirements for use on accessible routes
  - Max. angle of opening 120°
  - Fully adjustable for closing speed and latch action
  - Optional 'cushion stop' to prevent damage to the door (please note, this is not a full backcheck feature)
  - Optional hold-open kit (NOT TO BE USED ON FIRE DOORS)
  - Intumescent gasket kit required for fire door applications
  - Powder coated steel track arm with nylon runner
- 
- Testing: EN 1154 and CE Marked EN 1634 fire testing for use on timber doors up to 90 mins
- FD30 - Min. door thickness 44mm  
 FD60 - Min. door thickness 54mm  
 FD90 - Min. door thickness 58mm
- Certifire Approved (CF5292)
  - Guarantee: 10 years



Finishes

Available in a range of sprayed finishes, solid or plated metallic finishes. (see page 167 for details)

\* **Note:** CE marking applies to closers with the closer body door mounted

Briton 2400 Series

Concealed Cam Action Closer

Item Ref:	Description	Mounting Position	Finishes
2420.T	Concealed closer - adjustable power size 2 - 4	For door or frame mounting	PS; SE; SS
2420.CS	Optional cushion stop	Mounted in the standard slide track	n/a
2420.HP	Optional hold open kit	Mounted in the standard slide track	n/a
2420.IP	Intumescent gasket set for use with timber fire doors		

Briton 2420T - Door mounted

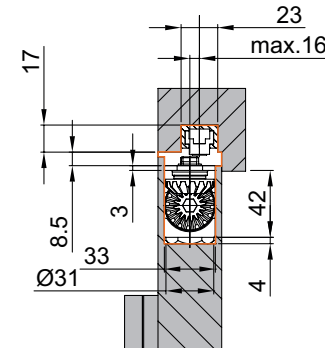

Briton 2420T - Transom mounted

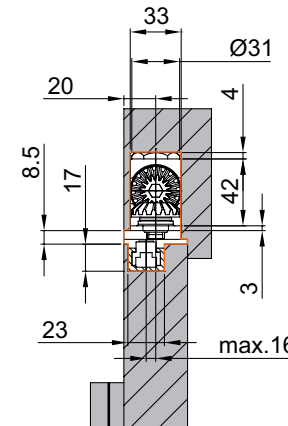

Mechanical Hold Open Unit

The hold open unit is achieved by use of a conversion kit which can be installed into the slide track of the mechanical closers in place of the standard pivot block. It enables doors to be securely held in the open position at the required pre-set angle (adjustable on installation from 80° to 120° depending on model and the mounting application).

The hold open facility can be easily released.

Please note, mechanical hold open is not permitted on fire door applications.

Intumescent gasket set (2420.IP)

A significant amount of fire resisting doorset material is removed when concealed closers are mortised into the door leaf. The intumescent gasket set will provide the additional performance that is required to protect the door from integrity failure during fire conditions.

It is particularly important with these closers to check that the details of the fire test certification are relevant to your intended door application.

Briton 2700 Series

Adjustable Power Cam Action Closers

General Description

The Briton 2700 Series of door controls is a precision manufactured cam-action slide track closer in a compact surface fixed unit. Providing easy opening with safe reliable closing the Briton 2700 Series bridges the gap between the requirements for fire and smoke control and ease of operation required for accessibility.

Principal Features

- CE Marked (AD0264)
- High efficiency cam action technology
- Simple to install using the unique Accufit installation system
- Capable of meeting BS8300 requirements for use on accessible routes
- Adjustable closing speed and FAST™ Power Adjust dial feature allows easy power adjustment to suit door conditions
- Choice of Slimline or Softline cover
- Cover secured by spring clips for quick installation and no visible fixings
- Fully adjustable for closing speed, latch action, backcheck, delayed action and hold-open

- Testing: EN 1154 and CE Marked EN 1634 fire testing for: 2 hour timber fire doors 1 hour steel fire doors
- Certifire Approved CF738
- Guarantee: 10 years



(AD0264)

Finishes

Available in a range of sprayed finishes, solid or plated metallic finishes. (see page 167 for details)

Options

- Two cover options
- 2721 transom mounting angle bracket is available for doors with a deep reveal (push side applications only)



Briton 2720BD.T.A with Slimline Cover Option in SES finish

Briton 2720BD.T.S with Softline Cover Option in SSS finish

Briton 2700 Series

Adjustable Power Cam Action Closers

Item Ref:	Description	Mounting Position	Finishes
2720BD.T.A	Closer with backcheck, Slimline cover - adjustable power size 2 - 5	Pull side of door or push side transom	SES; SSS
2721BD.T.A	Closer with backcheck, Slimline cover - adjustable power size 2 - 5	Push side of door or pull side transom*	
2720BD.T.S	Closer with backcheck, Softline cover - adjustable power size 2 - 5	Pull side of door or push side transom	
2721BD.T.S	Closer with backcheck, Softline cover - adjustable power size 2 - 5	Push side of door or pull side transom*	

\* power size 2 - 4 when pull side transom mounted

Briton 2720BD.T - door mounted pull side

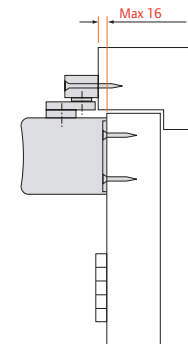

Briton 2721BD.T - door mounted push side

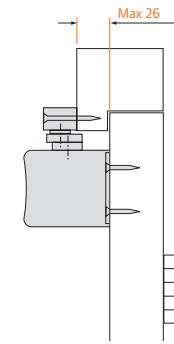

Briton 2720BD.T - transom mounted push side

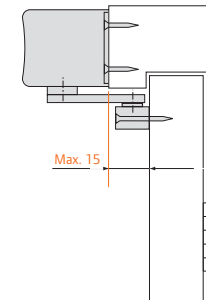

Briton 2721BD.T - transom mounted pull side

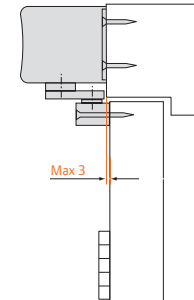

Certifire

2720BD.T Approval covers EN 2 - 5 for closers door mounted/pull side and EN 2- 4 for closers transom mounted/push side.

2721BD.T Approval covers EN 2 - 5 for closers door mounted/push side and transom mounted/pull side

Options

2721.DVP mounting bracket suitable for doors with a deep reveal.

Also suitable for use with Briton 2321.

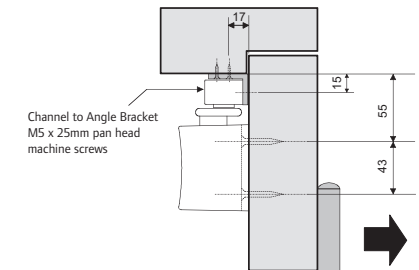

Briton 2700 Series

Electromagnetic Hold Open Closer

General Description

Linked to the building's alarm system, electromagnetic door controls eliminate the illegal practice of wedging doors open. This dangerous practice prevents a fire door functioning as it should in stopping the spread of flames and smoke in the event of a fire.

This option also offers a means of providing access through doors which might otherwise be difficult for elderly or disabled users to negotiate.



Principal Features

- CE Marked and fully certified to EN 1154 and EN 1155
- Designed for use on low voltage circuits 24V DC linked to a fire alarm
- High efficiency cam action technology
- Electromagnetic hold-open
- Adjustable backcheck
- Adjustable delayed action
- On-board test switch simulates fire alarm
- Capable of meeting BS8300 requirements

- Testing: EN 1154, EN 1155 and CE Marked  
EN 1634 fire testing for:  
2 hour timber fire doors  
1 hour steel fire doors  
Certifire Approved CF738
- Guarantee: 10 years mechanical  
2 years electrical



Certifire

2720BD.TE Approval covers EN 3 - 5 for closers door mounted/pull side  
2721BD.TE Approval covers EN 3 - 5 for closers door mounted/push side

Item Ref:	Description	Mounting Position	Finishes
2720BD.TE.A	Closer with backcheck, Slimline cover - adjustable power size 3 - 5	Door mounted pull side of door	SES; SSS
2721BD.TE.A	Closer with backcheck, Slimline cover - adjustable power size 3 - 5	Door mounted push side of door	
2720BD.TE.S	Closer with backcheck, Softline cover - adjustable power size 3 - 5	Door mounted pull side of door	SES; SSS
2721BD.TE.S	Closer with backcheck, Softline cover - adjustable power size 3 - 5	Door mounted push side of door	

Briton 996 Series

Electromagnetic Hold Open or Swing Free

Dual Function (set at installation)

**Hold Open.** In hold open operation, the door can be kept in an open position. When reactivated by alarm activation, the hold open mechanism is released and the door is closed under the spring power of the closer.

**Swing Free.** In swing free operation, the spring mechanism of the closer is temporarily disabled so that the door is free to open and close. When the alarm is activated the spring power of the closer is reactivated and will close the door if it is open.



Principal Features

- CE Marked (AE0007 - Briton 9963)  
(AE0008 - Briton 9964)  
(AE0012 - Briton 9965)
- Fully certified to EN 1154 and EN 1155
- Designed for use on low voltage circuits 24V DC linked to a fire alarm
- Dual function can be set to either Hold Open or Swing Free operation
- Capable of meeting BS8300 requirements
- Supplied with matching or black arms
- Testing: CE Marked to EN 1154 & EN 1155  
EN 1634 fire testing for:  
2 hour timber fire doors
- Certifire Approved CF109
- Guarantee: 10 years mechanical  
2 years electrical



Finishes

Available with matching armset or with black armset.  
(see page 167 for full details).

Certifire

Approval covers regular; transom and parallel applications as appropriate

Item Ref:	Description	Mounting Position	Finishes
9963/01	Fixed size 3 hold open or swing free closer	For regular & transom applications	SE; SES; SS; SSS
9963/66	Fixed size 3 hold open or swing free closer	For parallel applications	
9964/01	Fixed size 4 hold open or swing free closer	For regular & transom applications	SES; SSS
9964/66	Fixed size 4 hold open or swing free closer	For parallel applications	
9965/01	Fixed size 5 hold open or swing free closer	For regular & transom applications	SES; SSS
9965/66	Fixed size 5 hold open or swing free closer	For parallel applications	



Briton 500 Series

Electromagnetic Door Holders



503



533

General Description

When used in conjunction with a suitable door closing device, fire alarm and detection system, these Briton electromagnetic hold open devices permit fire doors to be held open during normal operation. In the event of fire or smoke detection the units are automatically de-activated allowing the doors to close under the action of the door closer.

Principal Features

- CE Marked (AE0009 - Briton 503)  
(AE0010 - Briton 553)
  - Fully certified to EN 1155
  - Built-in release / test button to simulate alarm activation
- 
- Testing: EN 1154, EN 1155 and CE Marked  
EN 1634 fire testing for:  
2 hour timber fire doors
- 
- Guarantee: 10 years mechanical  
2 years electrical



Finish

Available in a range of metallic and powder coated finishes.



533FMB.WH



533FMB.SE



533.C

Item Ref:	Description	Finishes
503	Contract wall magnet - surface mounted	WHS
533FMB	Floor mounting bracket for use with 503 or 533 magnet	WHS; SE; SS
533	Specification wall magnet - flush mounted	SE; SS
533.C	Wall mounted cover for 533 magnet	SE; SS

Briton 2820 Series

Floor Springs

General Description

The Briton 2820 Series floor spring is mounted into the floor screed and is suitable for high traffic single or double action doors.

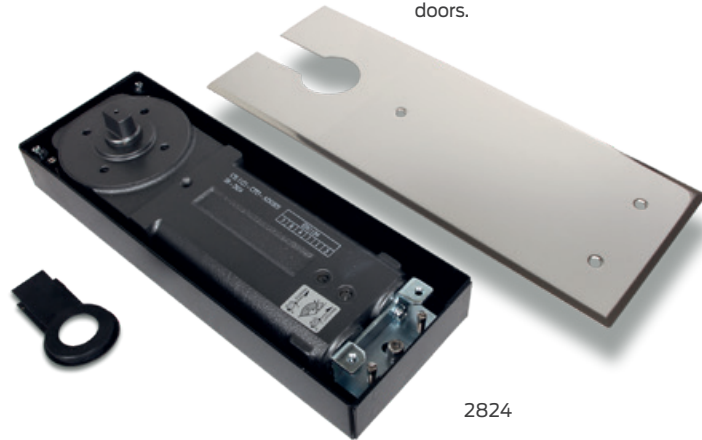

2824

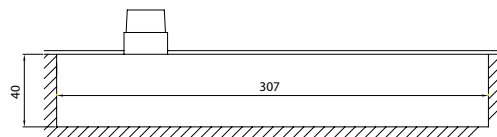
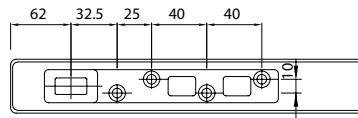
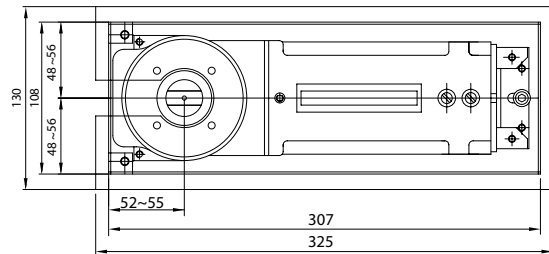

Principal Features

- CE Marked to EN 11545 (AD304 - Briton 2823) (AD0305 - Briton 2824)
- Fixed power versions sizes 2, 3 & 4
- Supplied complete with operating spindle suitable for glass patch fittings
- Low profile cement box 40mm deep
- Suitable for single or double action doors
- Suitable for doors up to 80kg
- Fully adjustable for closing speed and latch action
- Max. angle of opening 130°
- Removable cover plate
- Optional hold open facility 90° or 105°
- Max. door width 1100mm (Briton 2824)
- Max. door weight 80kg (Briton 2824)
- Doorstops must be fitted with these products

- Testing: EN 1154 and CE Marked  
EN 1634 fire testing for:  
1 hour timber fire doors
- Guarantee: 10 years (CE marked)  
2 years (non CE marked)



Finishes

Zinc coated cement box for corrosion resistance. Cover plate available in satin stainless steel. Polished stainless steel cover is available as an additional accessory\*.

For additional floor spring accessories please contact customer care.

Briton Door Controls

Selector

Item Ref:	Description	Finishes
2822	Floor spring fixed power EN size 2 - (not CE marked)	SS
2823	Floor spring fixed power EN size 3 - CE marked	SS
2824	Floor spring fixed power EN size 4 - CE marked	SS
2823.SS.HO.90	Floor spring fixed power EN size 3 with hold-open at 90° - (not CE marked)	SS
2823.SS.HO.105	Floor spring fixed power EN size 3 with hold-open at 105° - (not CE marked)	SS

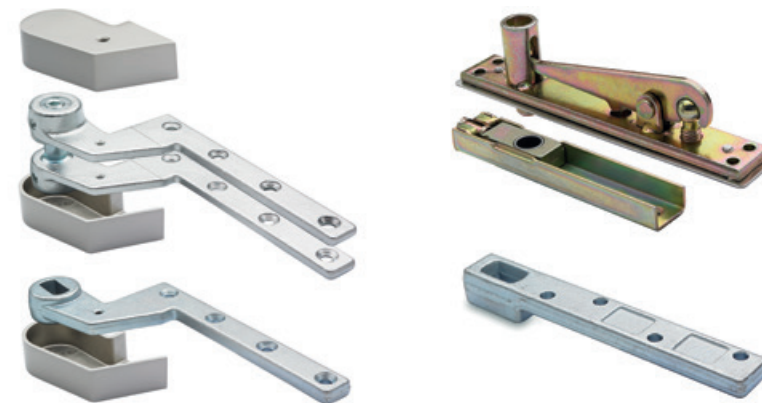

2820 SAP - Single action accessory pack

2820 DAP - Double action accessory pack

Item Ref:	Description	Finishes
2820 DAP	Accessory pack for double action doors	SS
2820 SAP	Accessory pack for single action doors c/w pivot covers	SS
2820.CP	Floor spring cover plate	SS
2820.CP.SAP	Cover caps for single action accessories	SS
2820.IP.DAP	Intumescent installation pack for double action application	-
2820.IP.SAP	Intumescent installation pack for single action application	-



**Panic or Emergency**

It is mandatory for all exit devices to comply with the latest revisions of EN 1125 or EN 179 and CE marking. All Briton 560, 570, 580 and 376 Series exit devices have been tested and certified to prove compliance with the latest standards EN 1125 & EN 179 which govern the application of panic and emergency exit hardware, but which standard applies to which application, and what determines which one I need?

**Panic Applications to EN 1125**

A 'panic' application is where the exit door is used by members of the public and must provide "safe and effective escape through the doorway with minimum effort and without prior knowledge of operation".

Typical applications include:

- Shops
- Schools
- Hospitals
- Theatres and Cinemas

Products used in panic applications require an operating device that covers the width of the door e.g. crossbars or touch bars.



**Emergency Applications to EN 179**

An 'emergency' application is where the exit door is in a low occupancy environment and will only be used by trained personnel, such as in a place of work never accessed by the public or people unfamiliar with the escape drill.

Typical applications include:

- Offices
- Private Flats & Apartments
- Factories
- Store Rooms & Boiler Rooms

Products used in emergency applications require only a single point of operation e.g. pushpads or levers.



**If in doubt ALWAYS choose a product certified to EN1125**

CE Classifications - Under both standards (EN 1125 and EN 179), each product is classified and graded to identify the level of compliance and type of unit within each category using a 10 digit code.

Category of Use 3 = high frequency	Durability 7 = 200,000 cycles	Door size/mass 6 = doors up to 200kg	Fire resistance (EN1634) B = suitable for fire doors	Safety Critical safety function	Corrosion resistance 3 = high resistance	Security 2 = up to 1000N	Device projection 1 = up to 150mm 2 = up to 100mm	Type of operation Touch bar/Push bar or Push pad	Field of door application relating to single/double doors
<b>3</b> (3)	<b>7</b> (6/7)	<b>6</b> (5-7)	<b>B</b> (0/A/B)	<b>1</b> (1)	<b>3</b> (3/4)	<b>2</b> (2-5)	<b>2</b> (1/2)	<b>A</b> (A/B)	<b>A</b> (A-C)

**GUIDE TO PANIC HARDWARE FINISHES**

The Briton 560 and 570 Series are available in a number of finish combinations.



**SE finish**  
Touch/Push bar in sprayed silver finish with all other components in black.



**SES finish**  
Touch/Push bar and end box covers in sprayed silver finish with all other components in matching grey finish.



**PS finish**  
Touch bar in polished stainless steel with all other components in black.



**SS finish**  
Touch bar in satin stainless steel with all other components in black.



**SSS finish**  
Touch bar, chassis and end box in satin stainless steel with all other components in black.



**PB finish**  
Touch bar in plated polished brass with all other components in black.

**Pullman Latches & Cable Covers**



**BM finish**  
Pullman latches, covers and cable covers are available in a semi matt black finish. Designed to be used with operators in SE, SS, PS or PB finish.



**SE finish**  
Pullman latches, covers and cable covers are available in a sprayed silver finish. Designed to be used with operators in SES finish.

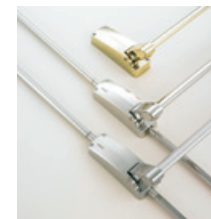

**376 Series Finishes**

The Briton 376 Series is available as standard in SE, sprayed silver finish. It is also available to order in a range of alternative sprayed metallic finishes and plated metal finishes including polished stainless steel, satin stainless steel and polished brass.

Please contact our Customer Care Centre on **0330 8080 617** for further information on availability and ordering.

Briton Panic

Selector

**Which system to choose**

Having first determined whether the application requires a panic or emergency exit solution there are number of additional considerations which will determine the most appropriate product. These could include:

- Aesthetic considerations - push bar or touch bar
- Designed to satisfy ANSI or EN standards
- Single point or multi-point latching for security
- Frequency of use may require a heavy duty solution
- Additional features such as hold-back or alarm connection
- Use of electric latch retraction to allow the use of electronic access control for external access
- Outside access device for external entry by key or digital code

\* Please note: when used in conjunction with a mortice lock, application is limited to a 1 hour fire rating

\*\* Please note: when fitted with an outside access device (OAD) or when used in conjunction with a mortice lock, application is limited to a 1 hour fire rating

	LEVEL 4 Panic Exit	LEVEL 3 Panic Exit	LEVEL 3 Panic Exit		LEVEL 1 Panic Exit	LEVEL 1 Panic Exit	LEVEL 2 Emergency Exit	LEVEL 1 Emergency Exit	LEVEL 1 Emergency Exit
Series	Briton 571EL	Briton 570 Series	Briton 560 Series		Briton 376	Briton 378	Briton 581	Briton 372	Briton 1438
Description	Modular panic exit hardware system	Modular panic exit hardware system	Modular panic exit hardware system		Regular panic exit hardware	Regular panic exit hardware	Modular emergency exit hardware system	Regular emergency exit hardware	Regular emergency exit hardware
Touch bar operation	■	■							
Push bar operation			■		■	■			
Push pad operation							■	■	■
CE marked to EN 1125	■	■	■		■	■			
CE marked to EN 179							■	■	■
Suitable for Door Weights	Up to 400kg	Up to 400kg	Up to 400kg		Up to 200kg	Up to 200kg	Up to 400kg	Up to 200kg	Up to 200kg
Rim latch device	■	■	■			■	■		■
Vertical bolt device	■	■	■		■		■		
Mortice nightlatch option		■				■	■		
Electric latch retraction	■								
No. of latching points	1 to 5	1 to 5	1 to 5		2	1	1 to 5	2	1
No. of test cycles	200,000	200,000	200,000		200,000	200,000	200,000	200,000	200,000
Certified for use on fire doors	Suitable for use on timber fire doors up to 2hr*				Suitable for use on timber fire doors up to 2hr**				
Suitable for single doors	■	■	■		■	■	■	■	■
Suitable for double doors	■	■	■		■	■	■	■	■
Typical applications	Medium to high end commercial applications	Medium to high end commercial applications	Medium to high end commercial applications		General contract applications	General contract applications	Medium to high end commercial applications	General contract applications	General contract applications

Briton 560 Series

Push Bar Panic Exit Hardware



General Description

Briton 560 Series panic exit devices have been designed to offer modular solutions. Comprising of a one-point locking push bar and optional modular locking elements, these units offer increased flexibility and adaptability to suit individual requirements. Each system can be built up by the use of additional pullman latching elements. Start by choosing an operating unit and add side or top/bottom pullman kits as required for multi point latching.

Ordering the right components

When ordering multi point latching options ensure you order a 561 operating device PLUS the appropriate pullman latch kit if required\*.

Make sure the finish of the pullman latch kit co-ordinates with the finish of the operating device.

For double door configurations ensure you order ALL the components listed in the table opposite.

Principal Features

- CE Marked to EN 1125 (AAA1589)
  - Unique assembly which reduces installation time by as much as 50%
  - Pullman design is connected to the operating device by a unique adjustable cable with matching covers
  - Operating heads and pullmans installed using quick fix mounting backplates
  - Robust construction for heavy traffic applications
  - Reversible on-site for left or right hand
  - Technologically advanced design with proven performance and reliability
  - Shaped cross bar end piece to allow easier access to door lock
  - Suitable for doors with a minimum clear opening width down to 500mm
  - Supplied with an easy clean socket
- 
- Testing: EN 1125 and CE Marked  
EN 1634 fire testing for: 2 hour timber fire doors

■ **Classification to EN 1125**  
**377 B 14 22 A A**

- Guarantee: 5 years



Finishes

Available in a choice of sprayed finishes, solid metallic finishes and polished and plated finishes (see page 37)

Briton 560 Series

Push Bar Panic Exit Hardware

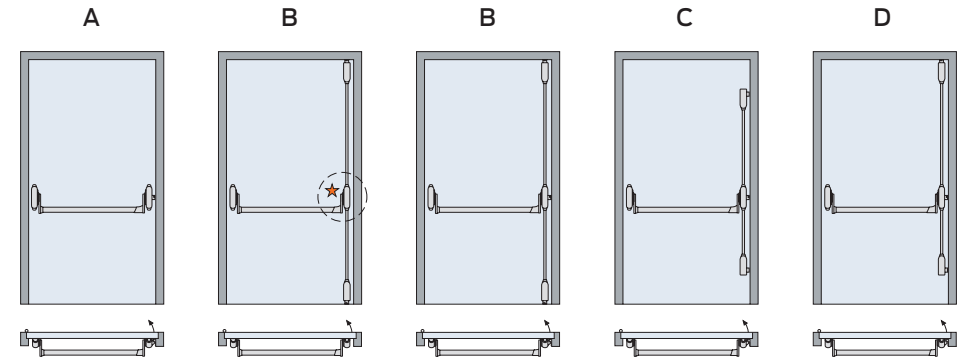

Item Ref:	Description	Illustration	Finishes
561	Push bar exit device with single point latch <sup>H</sup>	Appl.n A	SE; SES; SS; PS; PB
574.V	Pullman latch kit - top & bottom [used in addition to 561]	Appl.n B	SE - use with 561.SES
574.S	Pullman latch kit - upper & lower side acting [in addition to 561]	Appl.n C	BM - use with 561.SE,
574.VS.R	Pullman latch kit - top & lower side acting [in addition to 561] - for RH doors	Appl.n D	561.SS, 561.PS & 561.PB
574.VS.L	Pullman latch kit - top & lower side acting [in addition to 561] - for LH doors	Appl.n D	

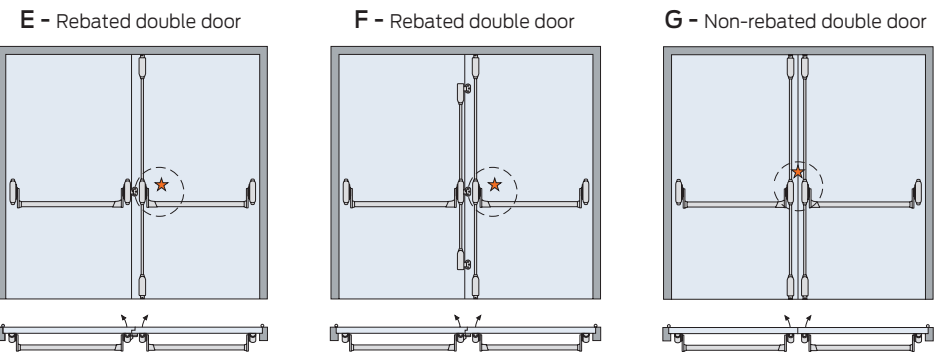

Description	Items Required	Illustration
Rebated double door - single point latching	561 + 561 + 574.V (select finish required)	Application E
Rebated double door - multi point latching	561 + 574.S + 561 + 574.V (select finish required)	Application F
Non-rebated double door - vertical latching	561 + 574.V + 561 + 574.V (select finish required)	Application G

<sup>H</sup> The latch may be disabled if required when used with pullman latch kits or when used as part of a double door configuration

Briton 570 Series

Touch Bar Panic Exit Hardware

Briton 570 Series

Touch Bar Panic Exit Hardware

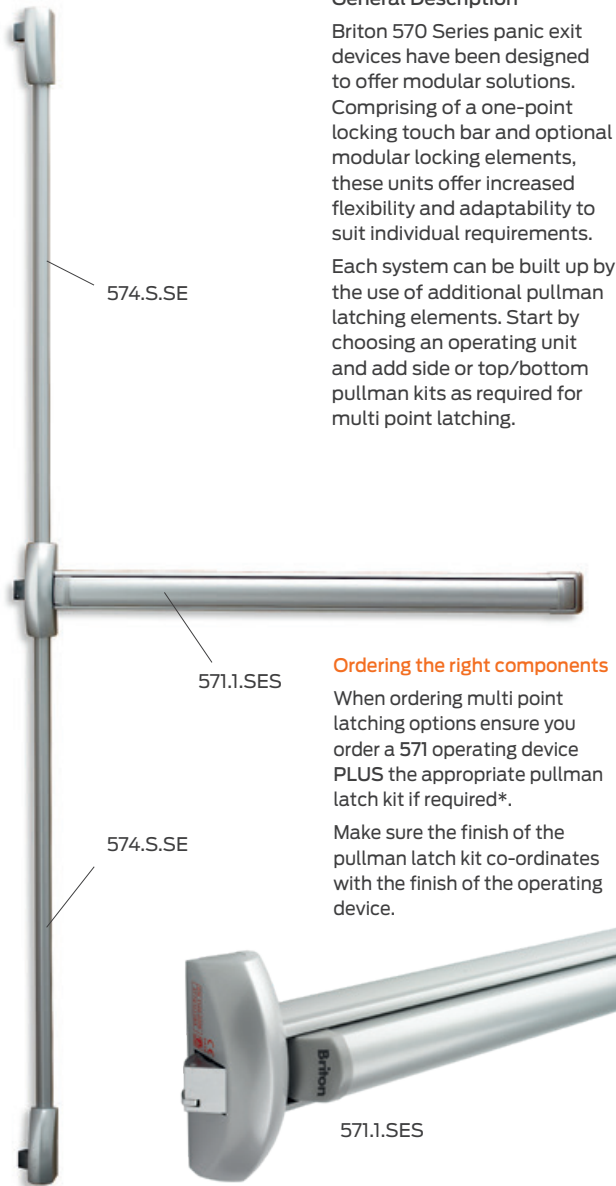

General Description

Briton 570 Series panic exit devices have been designed to offer modular solutions. Comprising of a one-point locking touch bar and optional modular locking elements, these units offer increased flexibility and adaptability to suit individual requirements. Each system can be built up by the use of additional pullman latching elements. Start by choosing an operating unit and add side or top/bottom pullman kits as required for multi point latching.

Ordering the right components

When ordering multi point latching options ensure you order a 571 operating device PLUS the appropriate pullman latch kit if required\*.

Make sure the finish of the pullman latch kit co-ordinates with the finish of the operating device.

Principal Features

- CE Marked to EN 1125 (AAA1588)
- Unique assembly which reduces installation time by as much as 50%
- Pullman design is connected to the operating device by a unique adjustable cable with matching covers
- Operating heads and pullmans installed using quick fix mounting backplates
- Robust construction for heavy traffic applications
- Non handed
- Technologically advanced design with proven performance and reliability
- Grip function on touch bar to allow the door to be pulled closed
- Suitable for doors with a minimum clear opening width down to 500mm
- Supplied with an easy clean socket
- Proective anti-bacterial coating

- Testing: EN 1125 and CE Marked EN 1634 fire testing for: 2 hour timber fire doors

Classification to EN 1125 377 B 1 4 2 2 B A

- Guarantee: 5 years



Finishes

Available in a choice of sprayed finishes, solid metallic finishes and polished and plated finishes (see page 37)

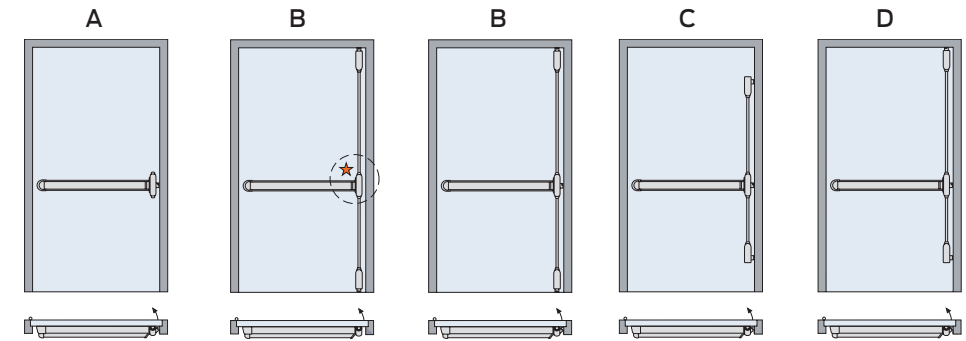

Item Ref:	Description	Illustration	Finishes
571.1	Touch bar exit device (1200mm length) with single point latch <sup>#</sup>	Application A	SE; SES
571.2	Touch bar exit device (840mm length) with single point latch <sup>#</sup>	Application A	
574.V	Pullman latch kit - top & bottom [in addition to 571]	Application B	SE - use with 571. SES
574.S	Pullman latch kit - upper & lower side acting [in addition to 571]	Application C	BM - use with 571.SE
574.VS.R	Pullman latch kit - top & lower side acting [in addition to 571] for RH doors	Application D	571.SS; 571.PS & 571.PB
574.VS.L	Pullman latch kit - top & lower side acting [in addition to 571] for LH doors	Application D	

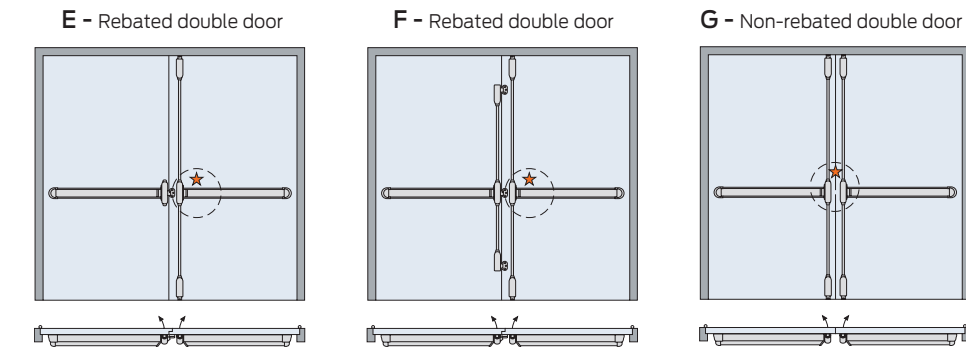

Description	Items Required	Illustration
Rebated double door - single point latching	571# + 571# + 574.V (select finish required)	Application E
Rebated double door - multi point latching	571# + 574.S + 571# + 574.V (select finish required)	Application F
Non-rebated double door - vertical latching	571# + 574.V + 571# + 574.V (select finish required)	Application G

\* The latch may be disabled if required when used with pullman latch kits

# Check the size of touch bar required - 571.1 or 571.2

Briton 571.EL

Electromechanical Touch Bar Device



General Description

The Briton 571 EL electronic panic exit device combines the mechanical features of the standard 570 Series touch bar panic exit hardware with electronic motorised control.

It presents innovative methods for opening doors, selecting access rights, providing open control, freedom and flexibility, including hierarchical authority and timings.

It is ideal for high footfall buildings such as schools, offices and hospitals, where many employee and staff entrances will also be one of the fire exits the building.

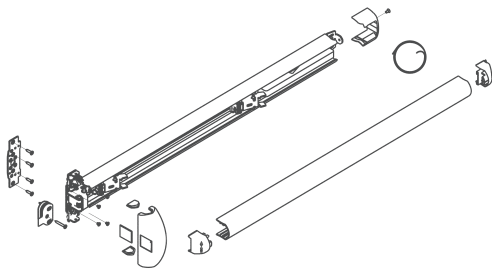

Principal Features

- CE Marked (1589)
- Fully certified to EN 1125
- Non handed
- Suitable for doors from 1200 mm down to 600 mm (with the same device)
- Suitable for use also with existing access control system
- Low power usage
- Power supply AC 12-20V (50/60 Hz), DC 12-24V
- Absorbed current (max) 1.5 A (12Vdc)
- Absorbed current (stand by, OUT1-OUT2 not connected) 5mA (12Vdc)
- Length of connecting cable 4 m
- Degree of protection IP20
- Operating temperature: -10 - +50°C
- Recommended power supply equal to or above 15 VA (not provided)
- Warning buzzer
- Timed latch withdrawal after opening, adjustable from 3 to 30 second
- Electronic dogging possible
- Protective anti-bacterial coating applied

■ Testing: EN 1125 and CE Marked

■ **Classification to EN 1125**

**377 B 1 4 2 2 B A**

■ Guarantee: 2 years



Finishes

As for 570 Series (see page 38)

Briton 571.EL

Electromechanical Touch Bar Device

Operation

The panic exit device has the same features as the mechanical version, in accordance with standard EN1125, and has the additional power-assisted opening function thanks to the interaction between the mechanics and the electronics.

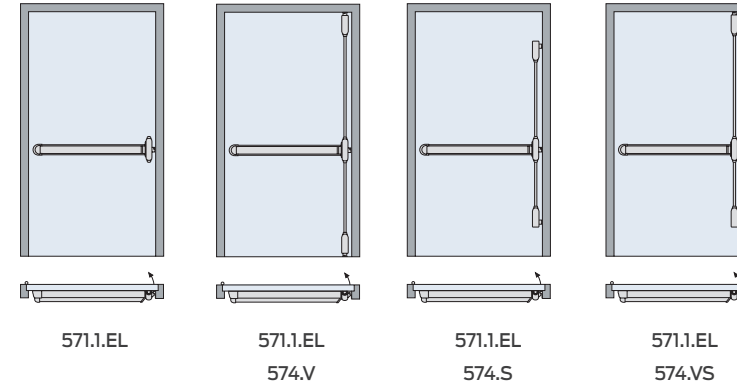

Locking options

The Briton 571.EL may be used as a single rim latch or in conjunction with the standard Briton 570 Series pullman latch kits to create multi-point latching for single or double door combinations. See page 43 for details.

Item Ref:	Description	EN Classification	Centres	Backset	Finishes
571.1.EL	1200mm motorised touch bar device	3M810F-B020	n/a	60mm	SS; PS
571.2.EL	840mm motorised touch bar device	3M810F-B020	n/a	60mm	SS; PS



The Briton 571 EL panic hardware device can be integrated with a wide range of electronic access control systems including the SimonsVoss and CISA access control options. This provides convenient and controlled access from the outside by pin code or contactless proximity reader, transforming emergency exit doors into effective "smart" entrances.

Briton 573.N

Touch Bar Panic Exit Hardware

General Description

Briton 573.N is a touch bar panic exit operator designed specifically for use with a mortice nightlatch. The device is suitable for single doors and the primary leaf of a non-rebated double door.

Principal Features

- CE Marked to EN 1125(1587)
- Robust construction for heavy traffic
- Reversible on site for right or left hand doors
- Technologically advanced design with proven performance and reliability
- Minimum clear opening width 500mm
- Supplied with cylinder mortice nightlatch with anti-thrust feature
- Nightlatch accepts both euro and oval profile cylinders (not supplied)
- Complete with steel box striker

■ Testing: EN 1125 and CE Marked  
EN 1634 fire testing for:  
1 hour timber fire doors

■ Classification to EN 1125

**377 B 1 4 2 2 B A**

■ Guarantee: 5 years



Finishes

Available in a choice of sprayed finishes, solid metallic finishes and polished and plated finishes (see page 37).

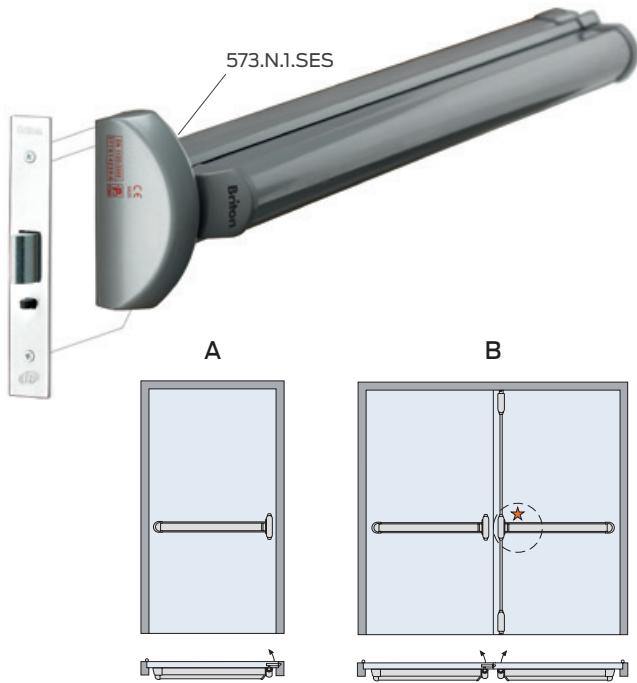

Item Ref:	Description	Illustration	Finishes
573.N.1	Touch bar exit device (1200mm length) with mortice nightlatch	Application A	SE; SES; PS; PB
573.N.2	Touch bar exit device (840mm length) with mortice nightlatch	Application A	

Description	Items Required	Illustration	Finishes
Non-rebated double door with mortice nightlatch and vertical bolts	573.N.1 + 571.1 + 574.V (for leaves > 900mm wide)	Application B	SE; SES; PS; PB
	573.N.2 + 571.2 + 574.V (for leaves up to 900mm wide)	Application B	

Briton 581

Push Pad Emergency Exit Hardware

General Description

Briton 581 is a Push Pad emergency exit latch designed to provide single point locking but capable of expansion using the Briton 574 pullman latch kits to provide multi point locking.

Principal Features

- CE Marked TO EN 179(2520)
- Robust construction for heavy traffic
- Non handed
- Technologically advanced design with proven performance and reliability
- Suitable for single doors and in combination on double doors
- Suitable for any door width
- Supplied with strike plate
- Slimline design - body width 42.8mm
- Suitable for doors over 200kg
- Security Grade 5 - 5000N
- Very high corrosion resistance

■ Testing: EN 179 and CE Marked

■ Classification to EN 179

**377 B 1 4 5 2 B A**

■ Guarantee: 5 years



Finishes

Available in SE or BM finishes (see page 37)



Item Ref:	Description	Finishes
581	Push pad emergency exit latch	SE; BM



Briton 560 - 570 Series Accessories



General Description

An additional side acting pullman latch kit which allows 2 or 3 point latching to be upgraded to up to 5 point latching.

Principal Features

- Suitable for both 560 and 570 devices
- Can be used above or below the operating device
- Non handed
- Available in SE or BM to match other pullman kits

Item Ref:	Description	Finishes
574.AS.R	Additional side pullman latch kit - for RH doors	SE; BM;
574.AS.L	Additional side pullman latch kit - for LH doors	



Item Ref:	Description	Finishes
574.STE	Easy clean socket for use with lower pullman latches [suitable for 560 and 570]	BM
574.STP	Strike for PVCu doors and frames [suitable for 560 and 570]	BM
566.AK	Alarm switch kit for inclusion in the operator end box [suitable for 560 Series only]	BM
566.DK	Dogging device to hold the operator in the open position [suitable for 560 Series only]	SE; BM
576.AK	Alarm switch kit for inclusion in the operator end box [suitable for 570 Series only]	BM
576.DK	Dogging device to hold the operator in the open position [suitable for 570 Series only]	SE; BM
576.RE	Top rod extension kit for use on high doors up to 3350mm [suitable for 560 and 570]	SE; BM

Briton Panic

Selector



General Description

A series of outside access devices which can be used with any of the Briton 560 and 570 Series panic and emergency exit devices. They provide a simple means of accessing the door from the outside.

Principal Features

- Fully compatible with Briton 560 and 570 Series devices
- For single and double doors when fitted to the first opening leaf of a pair
- Self handed or site reversible
- Anti-vandal design
- Clutch mechanism allows variable lever rotation
- BS 8300 compliant key retention (optional)
- Supplied with 40mm euro profile cylinder as standard (keyed alike or masterkeyed)
- Can be incorporated into existing masterkey system
- Suitable for doors 40mm - 70mm thick
- Easy retrofit on existing models (Retro Plate required)
- 9260 Digital code lock option has over 2000 non sequential code options
- 9260 supplied with extra long spindles for use with Briton exit devices
- 9260 code can be changed by removing the unit from the door
- Guarantee: 5 years

Finishes

Available in a range of sprayed finishes and plated metallic finishes (see page 167 for details)

Item Ref:	Description	Available for:	Finishes
1413.KE	Outside access device with knob operation	561; 571; 573; 574.S; 574.V; 574.VS; 581	SE; SS; PS; PB
1413.LE	Outside access device with lever operation		
9260	Outside access device with mechanical digital code	561; 571	PVD - SS

Please Note: 9260 mechanical digital lock is not compatible with Briton 573.N or Briton 581

Briton 376 Series

Push Bar Panic Exit Hardware



General Description

Briton 376 Series is a comprehensive range of push bar exit devices. Designed to satisfy requirements for panic and emergency exit applications, these long established panic exit devices are ideal for public areas where additional security is required.

Principal Features

- CE Marked (AAA011)
- Fully certified to EN 1125 or EN 179
- Products designed to satisfy panic exit applications and emergency exit applications
- Suitable for single and double doors
- Self handed or site reversible
- Durable aluminium die cast body and end boxes with extruded aluminium guides
- Steel shoot bolts
- Tubular steel shoots and cross bar can be cut on-site to suit door width and height
- Options include manual dogging, alarmed versions and pullman latches

- Testing: EN 1125 and CE Marked  
EN 1634 fire testing for:  
2 hour timber fire doors  
4 hour steel fire doors

- Certifire Approved CF5506
- **Classification to EN 1125**  
**376 B 1322 A A**

- Guarantee: 5 years



Finishes

Available in a range of sprayed finishes and plated metallic finishes (see page 167 for details)

Briton 376 Series

Push Bar Panic Exit Hardware

General Description

Push bar panic exit device with vertical bolts top and bottom. Suitable for single and double doors up to 2500mm (h) x 1300mm (w). Designed to satisfy requirements for panic and emergency exit applications. Features an anti-thrust device to prevent forced latch retraction and two point locking for extra security.



Additional Features

- CE Marked to EN 1125 for public applications
- Suitable for use on fire and smoke doors
- Clear fitting instructions for quick and easy installation
- Self-handed and site reversible
- Adjustable top & bottom shoots
- Supplied with 'Easy Clean' socket
- Tested to over 200,000 cycles



Item Ref:	Description	Finishes
376	Push bar panic exit bolt	
376.A	Push bar panic exit bolt with built-in alarm switch	
376.D	Push bar panic exit bolt with manual dogging	
376M	Push bar panic exit bolt with strike plate and fixings to suit metal doors	SE; PB; SS; PS
376M.P	Push bar panic exit bolt with pullman latches, strikes and fixings to suit metal doors	
376.P	Push bar panic exit bolt with pullman latches	
376.PD	Push bar panic exit bolt with pullman latches and manual dogging	



Optional pullman latches provide smooth and quiet operation



Briton 376MDS (illustrated above) for vertical panic bolts comprises 2 strike plates and 1 trip plate to activate the top tripper



**Briton 378** Push Bar Panic Exit Latch

**General Description**

Push bar panic exit rim latch with single point latching. Designed to satisfy panic and emergency exit applications. Suitable for doors up to 2500mm high x 1300mm wide, single and double when used in combination with the 376 panic bolt. Features an anti-thrust device to prevent unauthorised latch bolt retraction.

**Additional Features**

- CE Marked (AAA011)
- Certified to EN1125 for public applications
- Suitable for use on fire & smoke doors
- Clear fitting instructions for quick and easy installation
- Single point latching
- Self-handed and site reversible
- Tested to over 200,000 cycles



378.R.SE

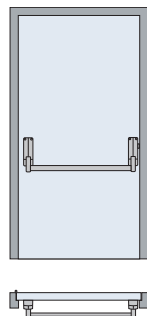

Item Ref:	Description	Finishes
378.R	Push bar panic exit latch - site reversible (supplied for RH doors)	SE; PB; SS; PS
378.D.R	Push bar panic exit latch with manual dogging - site reversible (supplied for RH doors)	

**Briton 377** Push Bar Panic Exit for Double Doors

**General Description**

Push bar panic exit device for double doors with single rim panic latch. Suitable for rebated double doors up to 2500mm high x 1300mm wide. Designed to satisfy the requirements for panic and emergency exit applications. Features three-point locking for extra security and anti-thrust device to prevent forced latch retraction.

**Additional Features**

- CE Marked (AAA011)
- Certified to EN 1125 for public applications
- Comprises of Briton 376 vertical panic bolt, 378 reversible rim panic latch and 378DDS double door strike in one convenient pack
- Designed to suit rebated double doors
- Suitable for use on fire & smoke doors
- Clear fitting instructions for quick and easy installation
- Self-handed and site reversible
- Adjustable top & bottom shoots



377.R.SE

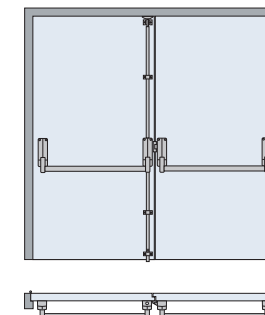

Item Ref:	Description	Finishes
377.R	Push bar panic exit combination for rebated double doors - site reversible (supplied for RH doors)	SE; PB; SS; PS

Briton 379.N

Push Bar Panic Exit with Mortice Nightlatch

General Description

The Briton 379.N push bar panic exit device with mortice panic nightlatch is suitable for single and double doors. Featuring an anti-thrust device to prevent forced latch retraction, this well-known exit device is ideal for public areas where additional security is required.



Additional Features

- CE Marked (AAA011)
- Certified to EN1125 for public applications
- Suitable for use on fire & smoke doors up to 1300mm wide
- Clear fitting instructions for quick and easy installation
- Supplied with dual profile cylinder mortice nightlatch (not supplied)
- Self-handed and site reversible.
- Tested to over 200,000 cycles



Item Ref:	Description	Finishes
379.N	Push bar panic exit device with mortice nightlatch	
379.NA	Push bar panic exit device with mortice nightlatch and built-in alarm switch	SE; PB; SS; PS
379.ND	Push bar panic exit device with mortice nightlatch with manual dogging	
379M.N	Push bar panic exit device with mortice nightlatch with fixings and strike for metal doors	

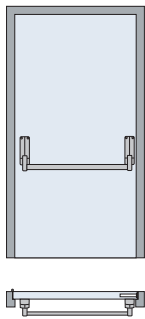

Briton 379MDS metal box strike for use with Briton 379.N mortice panic nightlatch. All Briton exit devices are supplied with self-tapping screws as standard, which are suitable for both timber and metal doorsets. For customers who prefer machine screws, alternative fixing packs are available. For more information please call our Customer Care team on 0330 8080 617.

Briton 372

Push Pad Emergency Exit Bolt

General Description

Push pad operated emergency exit device with vertical bolts top and bottom. Suitable for single and double doors up to 2500mm high.

Designed to satisfy requirements for emergency exit applications. Features an anti-thrust device to prevent forced latch retraction and two point locking for extra security.

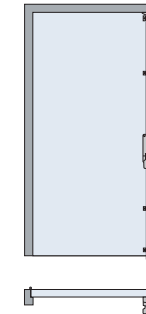

Additional Features

- CE marked to EN 179 (ABB020)
- Fully certified to EN 179 for use in Emergency Exit applications
- Double vertical bolts
- Suitable for single and double doors
- Suitable for doors up to 2500mm high
- Self handed
- Adjustable top and bottom shoots
- Supplied with easy clean socket
- Optional pullman latches
- **Classification to EN 179**  
**3 7 6 B 1 3 4 2 B A**



Item Ref:	Description	Finishes
372	Push pad emergency exit device with vertical bolts	
372M	Push pad emergency exit device with vertical bolts - with strikes and fixings to suit metal doors	SE; PB; SS; PS
372.P	Push pad emergency exit device with vertical bolts and pullman latches	
372M.P	Push pad emergency exit device with pullman latches - with strikes and fixings to suit metal doors	

Briton 1438

Push Pad Emergency Exit Latch

General Description

Push pad operated emergency exit device with single point rim latch. Suitable for single and double doors in combination with .

Designed to satisfy requirements for emergency exit applications. Features an anti-thrust device to prevent forced latch retraction and two point locking for extra security.

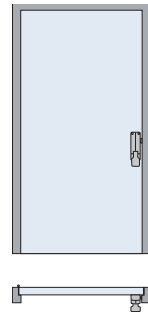

Additional Features

- CE marked to EN 179 (ABB020)
- Fully certified to EN 179 for use in Emergency Exit applications
- Pad operated rim latch with single point latching
- Suitable for single doors and in combination with Briton 372 on double doors
- Site reversible for left and right hand
- **Classification to EN 179**  
**3 7 6 B 1 3 4 2 B A**



Item Ref:	Description	Finishes
1438.R	Push pad emergency exit latch - site reversible (supplied for RH doors)	SE; PB; SS; PS
1438M.R	Push pad emergency exit latch with strike & fixings for metal doors - (supplied for RH doors)	

Briton 389.N

Push Pad Emergency Exit Mortice Nightlatch

Additional Features

- CE Marked (ABB020)
- Fully certified to EN 179
- Mortice nightlatch operation
- Suitable for use on single doors and the first opening leaf of a double door
- Site reversible for left or right hand
- Suitable for doors up to 1300mm wide
- Supplied with dual profile cylinder mortice nightlatch (cylinder not supplied)
- Anti thrust device prevents unauthorised latch bolt retraction
- **Classification to EN 179**  
**3 7 6 B 1 3 4 2 B A**

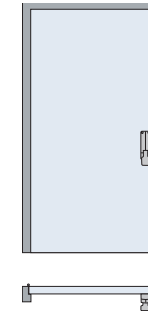

Item Ref:	Description	Finishes
389.N	Push pad emergency exit latch	SE; PB; SS; PS
389M.N	Push pad emergency exit latch with strike and fixings for metal doors	

Briton 376 Series

Accessories

General Description

A series of additional items are available to use with the Briton 376 Series panic and emergency exit hardware. Check suitability in the tables below.



378.DDS

Item Ref:	Description	Available for:	Finishes
376ELTS	Extra long top shoot for high doors up to 3350mm high	372; 376; 377	SE; PB; SS; PS
376FFKP	Flush fitting keeper plate for top latch fitted to a flush head frame	372; 376	PB; ZP
378DDS	Double door strike for use with double door arrangements	378; 1438	SE; PB; SS; PS
376MDS	Strike plate for vertical bolts for use with metal doors	372; 376; 377	PB; ZP
378MDS	Strike plate for latch for use with metal doors	378; 1438	SE; PB; SS; PS
379MDS	Box strike for mortice nightlatches fitted to a metal door	379	

Briton 376 Series

Outside Access Devices

General Description

A series of outside access devices which can be used with any of the Briton 376 Series panic and emergency exit devices. They provide a simple means of accessing the door from the outside.



1413.LE

- For single and double doors (fitted to the first opening leaf)
- Site reversible
- Anti-vandal design
- Clutch mechanism allows variable lever rotation
- BS 8300 compliant key retention (optional)
- Supplied with 40mm euro profile cylinder as standard (available keyed alike or masterkeyed)
- Can be incorporated into existing masterkey system
- For doors 40 - 70mm thick
- Easy retrofit on existing models (Retro Plate required)

1413.KE

- For single and double doors (fitted to the first opening leaf)
- Self handed
- BS 8300 compliant key retention (optional)
- Supplied with 40mm euro profile cylinder as standard (available keyed alike or masterkeyed)
- Can be incorporated into existing masterkey system
- For doors 40 - 70mm thick
- Easy retrofit on existing models (Retro Plate required)

9260

- For single and double doors (fitted to the first opening leaf)
- Site reversible
- Digital code lock with 2047 non sequential code options
- Supplied with extra long spindles to suit Briton exit devices
- For doors 40 - 60mm thick
- Code can be changed by removing the unit from the door

Please Note: 9260 mechanical digital lock is not compatible with Briton 379.N

Item Ref:	Description	Available for:	Finishes
1413.KE	Outside access device with knob operation	376 Series (all models)	SE; SS; PS; PB
1413.LE	Outside access device with lever operation	376 Series (all models)	
9260	Outside access device with mechanical digital code	376 & 378 (all models); 377; 372; 372.P; 1438	PVD - SS

**The basics of mechanical locking**

For most doors, particularly internal doors, a mechanical lockcase represents the most effective and direct means of providing privacy and security for commercial applications, and for all residential applications.

Mechanical locks fall into three principal categories:

- Mortice cylinder locks & latches
- Mortice lever locks & latches
- Rim/surface mounted locks & latches

**CE Mark explained**



Mechanical locks and latches intended for use on fire/smoke control doors are covered by the harmonised standard EN 12209 which sets out the requirements for testing and classifying locks suitable for CE marking in accordance with the Construction Products Regulation.

We recommend the use of a CE marked lockcase is the best way of ensuring the product you are using is fit for purpose and meets all legal requirements, particularly when used on fire doors.

**Locks on escape routes**

Locks fitted to doors which are on a defined emergency escape route must also be tested in accordance with **EN 179** and CE marked. The 9 digit code produced by assessment and testing defines the type of operation and the performance of each lock. For more information on EN 179 please refer to page 36.

**What is the Kitemark**



BS 3621:1980  
Licence KM6662

BS3621 remains the most popular standard for domestic lockcases and has been adopted by most insurance companies as the benchmark for security. Locks tested and approved to the standard may carry the famous kitemark to attest that the lockcase has successfully undergone tests against the most common forms of attack such as drilling.



**The Equalities Act - disability legislation**

Legislation aimed at providing universal accessibility of buildings requires service providers to make "reasonable adjustments to the physical features of their premises to overcome barriers to access".

To meet obligations under the Equalities Act, Approved Document M (ADM) of The Building Regulations and BS 8300 the following guidance relating to lock and latch cases is provided:

- The minimum distance from the door edge to the centre of the keyway (backset) – BS 8300 states a minimum of 54mm
- The distance between the handle follower and the centre of the keyway (lock centres) – BS 8300 states a minimum of 72mm
- 'Lever handles should be used wherever possible in conjunction with an upright mortice lock/latch' (BS 8300)

**Our Recommendation**

For commercial buildings we recommend the use of European style lockcases with 72mm centres and a minimum of 60mm backset. The Briton 5600, 5500 and 5400 Series euro profile cylinder mortice lockcases have been designed specifically to meet the requirements of the European standard EN 12209 and are CE marked where appropriate. Look out for locks with this symbol.



**Replacing an Existing Lockcase**

If you are replacing an existing mortice lockcase you can find out the size you require by:

1. Simply measuring from the centre of the keyhole to the forend of the lock. - this gives you the backset measurement.
2. Measure the distance from the cylinder aperture to the lever follower - this gives you the lock centres measurement.

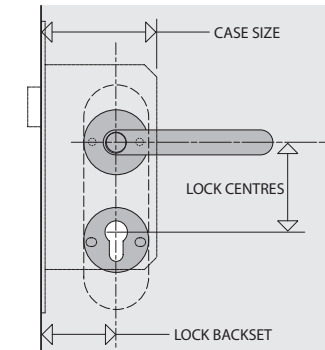

**EN 12209 is the European standard for lockcases**

Physical characteristics of type, operation and performance of lockcases is tested/assessed in accordance with EN 12209 (and EN 179 for locks on escape routes). This produces an 11 digit (EN 12209) classification code which allows comparison between different locks that conform to the standard. See examples below.

1. <b>Category of Use</b> Defines the frequency of use. Grade 3 - High frequency of use by public or others with little incentive to exercise care and with a high chance of misuse	<b>3</b> 1 - 3	
2. <b>Durability</b> Performance testing of the product through various cycle tests. Durability and Load On Latch (LOL) are identified Grade H - 200,000 cycles; 10N (LOL) Grade X - 200,000 cycles; 120N (LOL)	<b>X</b> A - X	
3. <b>Door Mass &amp; Closing Force</b> The mass of the door that the product is suitable for: Grade 8 - Up to 200kg; 15N max closing force required	<b>8</b> 1 - 9	
4. <b>Fire Behaviour</b> Suitability for use on fire doors through testing to EN 1634 Grade 1 - Approved for fire door use subject to assessment	<b>1</b> 1	
5. <b>Safety</b> Safety category of the product. Grade 0 - No safety requirement	<b>0</b> 0	
6. <b>Corrosion Resistance</b> Level of corrosion resistance to EN 1670: Grade F - High resistance 96 hours at -20 °C to +80 °C Grade G - Very high resistance 240 hours at -20 °C to +80 °C	<b>G</b> 0 - G	
7. <b>Security</b> Security and drill resistance levels are identified Grade 4 - High security with no drill resistance	<b>4</b> 1 - 7	
8. <b>Field of Door Application</b> Defines the applications the product is suitable for: Grade B - Suitable for hinged doors in a mortice application and without forend support	<b>B</b> A - T	
9. <b>Type of Key Operation</b> Defines the type of key operation and locking type: Grade 0 - Not applicable Grade A - Cylinder lock or latch with manual locking Grade C - Cylinder lock or latch with intermediate locking	<b>A</b> 0 - H	
10. <b>Type of Spindle Operation</b> Method of operation and compatible door furniture Grade 0 - Lock or latch without follower Grade 2 - Lock or latch for unsprung lever handle operation	<b>2</b> 0 - 4	
11. <b>Key Identification Requirement</b> Number of detaining elements and effective differs Grade 0 - Indicates no requirement for key identification	<b>0</b> 0	

Lockcase Selector

Feature	Briton 5600 Series	Briton 5500 Series	Briton 5400 Series	Briton 5200 Series	CISA HD Series	Legge BS Series	Legge Locks & Latches	Legge Rim Locks	Feature
LOCK TYPE	Mortice cylinder lockcases	Mortice cylinder lockcases	Mortice cylinder lockcases	Mortice cylinder lockcases	Mortice cylinder lockcases	Mortice lever lockcases	Mortice locks and latches	Rim locks and latches	LOCK TYPE
Performance Level	Level 5 & 4	Level 5 & 4	Level 4	Level 3	Level 5 & 4	Level 2	Level 1	Level 1	Performance Level
Lockcase mounting	Mortice	Mortice	Mortice	Mortice	Mortice	Mortice	Mortice	Rim/Surface	Lockcase mounting
Dimensional co-ordination to DIN18251	■	■	■		■				Dimensional co-ordination to DIN18251
CE marked	■	■	■		■				CE marked
Fully tested to EN12209	■	■	■		■				Fully tested to EN12209
Fully tested to EN179	■	■			■				Fully tested to EN179
Kitemarked to BS3621						■			Kitemarked to BS3621
Single throw deadbolt action	■	■		■	■	■			Single throw deadbolt action
Double throw deadbolt action			■						Double throw deadbolt action
Fire tested to EN1634 for timber doors	90 mins	2 hours	2 hours	90 mins		90 mins			Fire tested to EN1634 for timber doors
Fire tested to EN1634 for metal doors	4 hours	4 hours	4 hours	4 hours		4 hours			Fire tested to EN1634 for metal doors
Fire tested UL LISTED R 14945(N)					60 mins				Fire tested UL LISTED R 14945(N)
Certifire approved		■	■						Certifire approved
Guarantee	10 years	10 years	5 years	5 years	5 years	10 years	5 years	1 year	Guarantee

Locking Functions									Locking Functions
Locking function by:	Euro Cylinder	Euro Cylinder	Euro Cylinder	Euro or Oval Cylinder	Euro Cylinder	Lever Key	Lever Key	Lever Key or Rim Cylinder	Locking function by:
Deadlock		■	■	■	■	■	■		Deadlock
Sashlock		■	■	■	■	■	■	■	Sashlock
Bathroom lock		■	■	■	■	■	■	■	Bathroom lock
Bathroom deadbolt		■					■		Bathroom deadbolt
Latch		■	■	■	■	■	■	■	Latch
Nightlatch with hold-back		■		■			■	■	Nightlatch with hold-back
Nightlatch without hold-back		■		■	■		■		Nightlatch without hold-back
Nightlatch with anti-thrust	■			■					Nightlatch with anti-thrust
Escape sashlock - non split follower		■			■				Escape sashlock - non split follower
Escape sashlock - split follower function	■				■				Escape sashlock - split follower function

■ Standard feature



Briton 5600 Series

Euro Profile Cylinder Lockcases



General Description

The Briton 5600 Series is a high quality, euro profile mortice lockcase offering Nightlatch and Escape Sashlock functions.

Principal Features

- CE marked (see individual details)
  - Conforms to EN 12209
  - Escape lock is approved to EN 179 for emergency exit applications when used with specific levers
  - 60mm backset and 72mm centres in line with guidance of BS 8300
  - Quick reversible latch for easy on-site handing
  - Smooth and quiet latch action
  - Single throw cylinder action
  - Suitable for bolt through furniture fixings at 38mm centres and with guided holes to prevent ingress of material and assist furniture installation
  - Suitable for unsprung lever furniture
- Testing: EN 12209 and CE Marked  
EN 179 (Briton 5660 only)  
EN 1634 fire testing for:  
90 mins timber fire doors  
and 4hr metal doors

- Guarantee: 10 years



IMPORTANT - Fire Door Installation:

When installing this product to a fire resistant timber door the lock must be fitted in conjunction with the intumescent protection to ensure that the integrity of the door is maintained in a fire situation.

Finishes

Available with a satin stainless steel forend with matching strike plate.

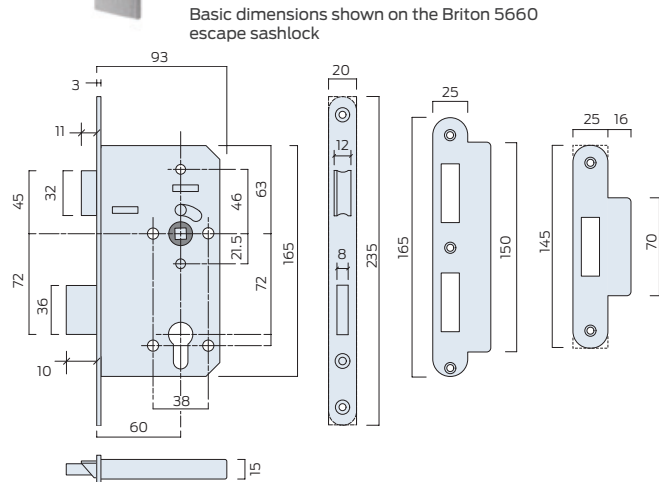

Basic dimensions shown on the Briton 5660 escape sashlock

Briton 5650

Euro Profile Nightlatch - Anti-Thrust

5650.60.S

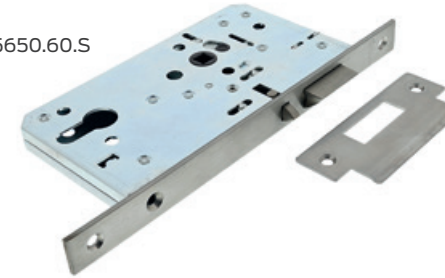

Lock dimensions as for sashlock (see page 64)

Additional Features

- Nightlatch function operated by a half set of levers, with the lever on the inside to retract the latchbolt
- Single cylinder on the outside operates the latchbolt with a single key turn
- Anti-thrust latch prevents forced latchbolt retraction
- Latchbolt is automatically locked by anti-thrust bolt



Item Ref:	Description	EN Classification	Centres	Backset	Finishes
5650.60.R	Euro profile nightlatch - radius forend	3X810F1BB20	72mm	60mm	SS
5650.60.S	Euro profile nightlatch - square forend	3X810F1BB20	72mm	60mm	SS

Briton 5660

Euro Profile Escape Sashlock - Split Follower

Please Note:

For EN 179 compliance, the lock must be fitted with compatible lever furniture (See CE certification for further details). This lock incorporates a split follower function.

For further information please call 0330 8080 617

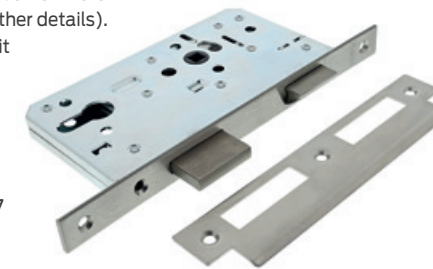

Lock dimensions as for sashlock (see page 64)

Additional Features

- Latchbolt withdrawn by lever handle from both sides
- Split follower function enables both the deadbolt and latchbolt to be withdrawn simultaneously by inside lever handle
- Easily reversible escape mechanism



(AG5104) - EN 12209  
(ABB5012) - EN 179

Item Ref:	Description	EN Classification	Centres	Backset	Finishes
5660.60.R	Euro profile escape sashlock - radius forend	EN 12209 - 3X810F3BA20	72mm	60mm	SS
5660.60.S	Euro profile escape sashlock - square forend	EN 179 - 376B1442AB/D	72mm	60mm	SS

Briton 5500 Series

Euro Profile Cylinder Lockcases



General Description

The Briton 5500 Series is a heavy duty range of euro profile cylinder lockcases offering a comprehensive range of functions.

Principal Features

- CE marked (see individual details)
  - Conforms to EN 12209
  - Escape lock is approved to EN 179 for emergency exit applications when used with specific levers
  - 60mm backset and 72mm centres in line with guidance of BS 8300
  - Quick reversible latch for easy on-site handing
  - Smooth and quiet latch action
  - Single throw cylinder action
  - Suitable for bolt through furniture fixings at 38mm centres and with guided holes to prevent ingress of material and assist furniture installation
  - Suitable for unsprung lever furniture
- Testing: EN 12209 and CE Marked  
EN 179 (Briton 5560 only)  
EN 1634 fire testing for:  
90 mins timber fire doors  
4 hour steel fire doors
- Certifire Approved: CF741
  - Guarantee: 10 years



IMPORTANT - Fire Door Installation:

When installing this product to a fire resistant timber door the lock must be fitted in conjunction with the intumescent protection to ensure that the integrity of the door is maintained in a fire situation.

Finishes

Available with a satin stainless steel, polished stainless steel, or polished brass forend with matching strike plate.

Basic dimensions shown on the Briton 5530 bathroom lock (left) and 5520 sashlock (right)

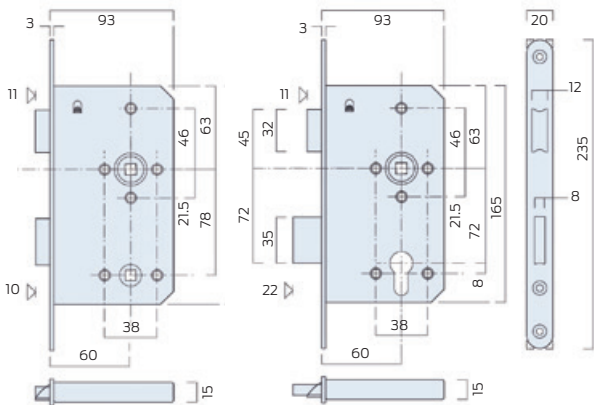

Briton 5510

Euro Profile Cylinder Deadlock

5510.60.R



Additional Features

- Suitable for use on doors without lever furniture that require locking
- Deadbolt can be operated from one side or both as required depending on the cylinder selected



Lock dimensions as for sashlock (see page 66)

Item Ref:	Description	EN Classification	Centres	Backset	Finishes
5510.60.R	Mortice euro profile cylinder deadlock - radius forend	3X810G3HA00	n/a	60mm	SS; PS; PB
5510.60.S	Mortice euro profile cylinder deadlock - square forend	3X810G3HA00	n/a	60mm	SS; PS; PB

Briton 5520

Euro Profile Cylinder Sashlock

5520.60.R

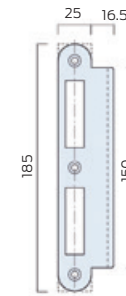

Additional Features

- For lockable doors with lever furniture to withdraw the latchbolt
- Deadbolt can be operated from one side or both as required depending on the cylinder selected
- Cylinder latch function enables the cylinder to withdraw the deadbolt on the first turn and the latch on the second turn of the cylinder



Lock dimensions as for sashlock (see page 66)

Item Ref:	Description	EN Classification	Centres	Backset	Finishes
5520.60.R	Mortice euro profile cylinder sashlock - radius forend	3X810G3HA20	72mm	60mm	SS; PS; PB
5520.60.S	Mortice euro profile cylinder sashlock - square forend	3X810G3HA20	72mm	60mm	SS; PS; PB

Briton 5530 & 5535 Bathroom Locks

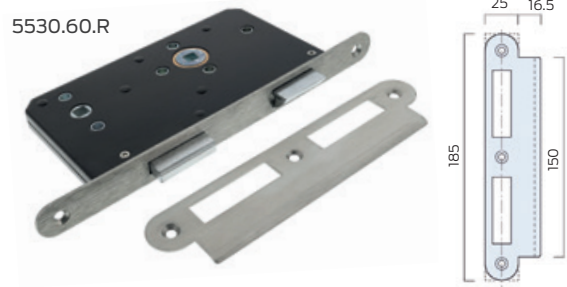

Lock dimensions shown on page 66

- Additional Features**
- Suitable for use on bathroom doors requiring a privacy function
  - 10mm throw deadbolt operated by thumbturn (requires a thumbturn and outside indicator/emergency release)
  - Bathroom function has 8mm follower
  - Bathroom deadlock has no latchbolt or lever follower - Thumbturn operation only



Item Ref:	Description	EN Classification	Centres	Backset	Finishes
5530.60.R	Mortice bathroom lock - radius forend	3X810G-H020	78mm	60mm	SS; PS; PB
5530.60.S	Mortice bathroom lock - square forend	3X810G-H020	78mm	60mm	SS; PS; PB
5535.60.R	Mortice bathroom deadlock - radius forend	3X810G-H000	n/a	60mm	SS; PS; PB
5535.60.S	Mortice bathroom deadlock - square forend	3X810G-H000	n/a	60mm	SS; PS; PB

Briton 5540 Latch



Lock dimensions as for sashlock (see page 66)

- Additional Features**
- Suitable for use on doors with lever furniture which are not required to be locked



Item Ref:	Description	EN Classification	Centres	Backset	Finishes
5540.60.R	Mortice latch - radius forend	3X810G-H020	n/a	60mm	SS; PS; PB
5540.60.S	Mortice latch - square forend	3X810G-H020	n/a	60mm	SS; PS; PB

Briton 5550 & 5555 Euro Profile Cylinder Nightlatch



Lock dimensions as for sashlock (see page 66)

- Additional Features**
- Nightlatch function operated by a half set of levers, with the lever on the inside to retract the latchbolt.
  - Single cylinder on the outside operates the latchbolt with a single key turn
  - Available with or without hold-back function operated by snib in the forend



Item Ref:	Description	EN Classification	Centres	Backset	Finishes
5550.60.R	Nightlatch - radius forend - with hold-back	not CE marked	72mm	60mm	SS; PS; PB
5550.60.S	Nightlatch - square forend - with hold-back	not CE marked	72mm	60mm	SS; PS; PB
5555.60.R	Nightlatch - radius forend - without hold-back	3X810G-H020	72mm	60mm	SS; PS; PB
5555.60.S	Nightlatch - square forend - without hold-back	3X810G-H020	72mm	60mm	SS; PS; PB

Briton 5560 Euro Profile Escape Sashlock



**Please Note:**  
For EN 179 compliance, the lock must be fitted with compatible lever furniture (See CE certification for further details). This lock does not incorporate a split follower function and must not be used with a lever on the outside of the door or thumbturn on the inside.

For further information please contact 0330 8080 617

- Additional Features**
- Deadbolt can be thrown and withdrawn from one or both sides depending on cylinder selected
  - Cylinder to latch function enables the cylinder to withdraw the deadbolt on the first turn and the latchbolt on the second turn of the key
  - CE marked conforming to the requirements of EN 179 for use on emergency exits



Item Ref:	Description	EN Classifications	Centres	Backset	Finishes
5560.60.R	Mortice escape sashlock - radius forend	EN 12209 - 3X810G3HA20	n/a	60mm	SS; PS; PB
5560.60.S	Mortice escape sashlock - square forend	EN 179 - 376B1442AB/D	n/a	60mm	SS; PS; PB

Briton 5400 Series

Euro Profile Cylinder Lockcases



General Description

Briton 5400 Series is a contract range of euro profile cylinder lockcases designed for all medium to high usage applications.

Principal Features

- CE marked (see individual details)
  - Conforms to EN 12209
  - 60mm backset and 72mm centres in line with guidance of BS 8300
  - Dimensional co-ordination across the range to DIN 18251 means lock functions can be easily interchanged and doors can be factory prepared
  - Quick reversible latch for easy on-site handing
  - Double throw cylinder action
  - Suitable for bolt through furniture fixings at 38mm centres
  - Suitable for light unsprung lever furniture
- 
- Testing: EN 12209 and CE Marked  
EN 1634 fire testing for:  
90 mins timber fire doors  
4 hour steel fire doors
  - Certifire Approved: CF741
  - Guarantee: 5 years

Basic dimensions shown on the Briton 5430 bathroom lock (left) and 5420 sashlock (right)

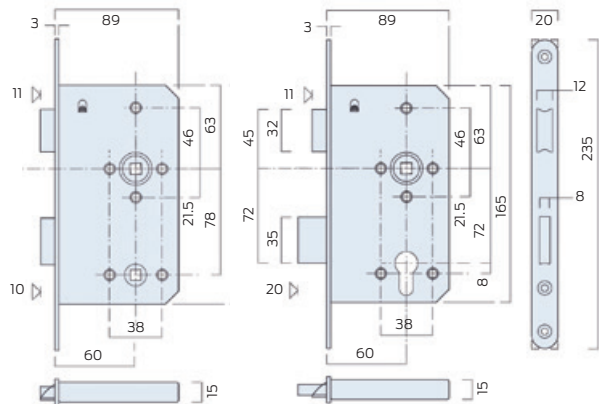

IMPORTANT - Fire Door Installation:

When installing this product to a fire resistant door you must ensure:

A suitable door closers such as a Briton 2130 is fitted on all fire doors in accordance with Approved Document B (Fire Safety) 2006 and the new Construction Products Regulations 2013.

When fitted to timber doors the lock must be fitted in conjunction with the intumescent protection to ensure that the integrity of the door is maintained in a fire situation.

Finishes

Available with a satin or polished stainless steel forend with matching strike plate

Briton 5410

Euro Profile Cylinder Deadlock

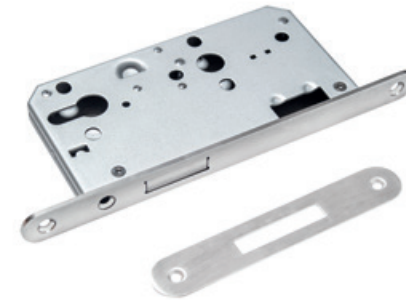

Strike plate dimensions shown opposite - all main lock dimensions as for sashlock (see page 70)

Additional Features

- Suitable for use on doors without lever furniture that require locking
- Deadbolt can be operated from one side or both as required depending on the cylinder selected
- Must be used with a suitable door closer on all fire doors



Item Ref:	Description	EN Classification	Centres	Backset	Finishes
5410.60.R	Mortice euro profile cylinder deadlock - radius forend	3X810G2BC00	n/a	60mm	SS; PS
5410.60.S	Mortice euro profile cylinder deadlock - square forend	3X810G2BC00	n/a	60mm	SS; PS

Briton 5420

Euro Profile Cylinder Sashlock

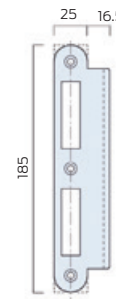
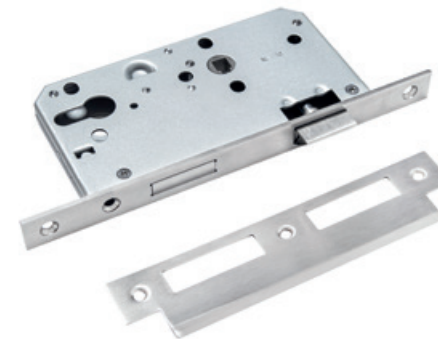

Lock dimensions shown on page 70

Additional Features

- For lockable doors with lever furniture to withdraw the latchbolt
- Deadbolt can be operated from one side or both as required depending on the cylinder selected
- Cylinder latch function enables the cylinder to withdraw the deadbolt on the first turn and the latch on the second turn of the cylinder
- Must be used with a suitable door closer on all fire doors



Item Ref:	Description	EN Classification	Centres	Backset	Finishes
5420.60.R	Mortice euro profile cylinder sashlock - radius forend	3X810G2BC20	72mm	60mm	SS; PS
5420.60.S	Mortice euro profile cylinder sashlock - square forend	3X810G2BC20	72mm	60mm	SS; PS

**Briton 5430**

**Bathroom Lock**

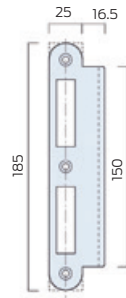
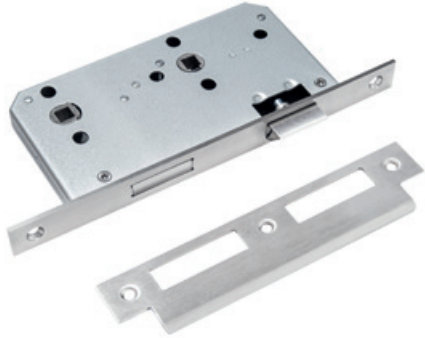

**Additional Features**

- Suitable for use on bathroom doors requiring a privacy function
- 10mm throw deadbolt operated by thumbturn (requires a thumbturn and outside indicator/emergency release)
- Bathroom function has 8mm follower
- Bathroom deadlock has no latchbolt or lever follower - Thumbturn operation only
- Must be used with a suitable door closer on all fire doors



Lock dimensions shown on page 70

Item Ref:	Description	EN Classification	Centres	Backset	Finishes
5430.60.R	Mortice bathroom lock with radius forend	3X810G-BG20	78mm	60mm	SS; PS
5430.60.S	Mortice bathroom lock with square forend	3X810G-BG20	78mm	60mm	SS; PS

**Briton 5440**

**Latch**

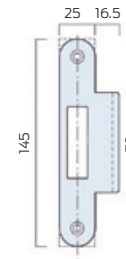
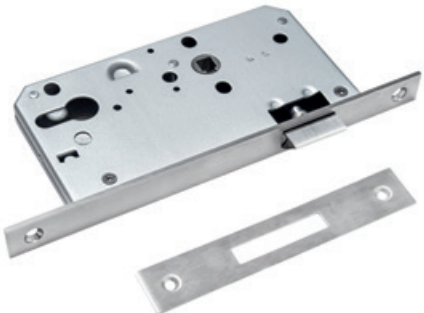

**Additional Features**

- Suitable for use on doors with lever furniture which are not required to be locked
- Must be used with a suitable door closer on all fire doors



Lock dimensions shown on page 70

Item Ref:	Description	EN Classification	Centres	Backset	Finishes
5440.60.R	Mortice latch - radius forend	3X810G-B020	n/a	60mm	SS; PS
5440.60.S	Mortice latch - square forend	3X810G-B020	n/a	60mm	SS; PS

**Briton 5470**

**Roller Bolt**

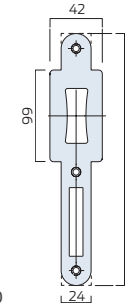
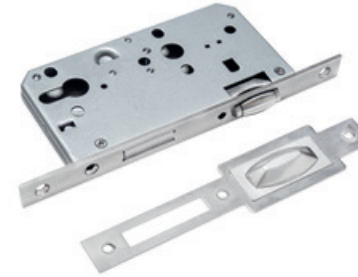

**Additional Features**

- For lockable doors fitted with pull handles



Lock dimensions shown on page 70

Item Ref:	Description	EN Classification	Centres	Backset	Finishes
5470.60.R	Mortice lock with roller bolt - radius forend	NPDC810-0B000	78mm	60mm	SS; PS
5470.60.S	Mortice lock with roller bolt - square forend	NPDC810-0B000	78mm	60mm	SS; PS

**Briton 5500 Series**

**Accessories**

**General Description**

A full range of accessories, including box strikes, and full length strike plates is available to replace the standard strike supplied with the lockcase on 5600, 5500 and 5400 series lockcases.

**Principal Features - Box Strikes**

- Solid zinc alloy strike boxes with black powder coated finish
- Used with standard strike plate supplied with the lockcase
- Suits round and square forends
- Pack contains 1 x strike box, 1 x screw pack

**Full Strike Plates**

- Stainless steel strike plates to replace the standard strike supplied with the lockcase
- Allows commonframe preparation
- Latch strikes are supplied for LH or RH applications
- Pack contains 1 x full round or full square strike plate, 1 x screw pack



Item Ref:	Lock Type	To Suit Lockcases	Finishes
5500.IP	Intumescent pack for use on fire doors	All 5600, 5500 and 5400 Series locks	n/a
5000.001	Heavy duty box strike for latch & bolt	5660; 5520; 5530; 5560; 5420; 5430	Black
5000.003	Square rebate kit 13mm for sashlock	5520; 5420; 5220	SS
5000.005	Square rebate kit 13mm for latch	5540; 5440; 5440	SS
5000.007	Square rebate kit 13mm for deadlock	5510; 5410; 5210	SS
5000.009	Standard radius strike for sashlocks	5520; 5420	SS
5000.010	Standard square strike for sashlocks	5520; 5420	SS
5000.011	Standard radius strike for latches	5540; 5440	SS
5000.013	Standard radius strike for deadlocks	5510; 5410	SS
5000.022	Heavy duty box strike for sashlocks	5660; 5520; 5560; 5420	Black

**Briton 5200 Series**

**Dual Profile Cylinder Lockcases**

**General Description**

The Briton 5200 Series is a contract quality, mortice lockcase range which can be used with euro profile or oval profile cylinders. The Series offers the most common range of lock functions.

**Principal Features**

- CE marked to EN 12209
- 57mm backset and 57mm centres
- Dimensional co-ordination across the range allows locks to be interchanged and doors can be factory prepared
- Unique X-Tension feature allows the spring tension to be adjusted
- Quick reversible latch for easy on-site handing
- Dual profile can be used with euro profile or oval profile cylinders
- Single throw hardened steel deadbolt to protect from sawing
- Suitable for bolt through furniture fixings at 38mm centres
- Suitable for unsprung lever furniture
- Supplied with square forend

- Testing: EN 12209 and CE Marked  
EN 1634 fire testing for:  
90 mins timber fire doors  
4 hour steel fire doors

- Guarantee: 10 years



**IMPORTANT - Fire Door Installation:**

When installing this product to a fire resistant timber door the lock must be fitted in conjunction with the intumescent protection to ensure that the integrity of the door is maintained in a fire situation.

**Finishes**

Available with a satin stainless steel or polished brass forend & matching strike plate

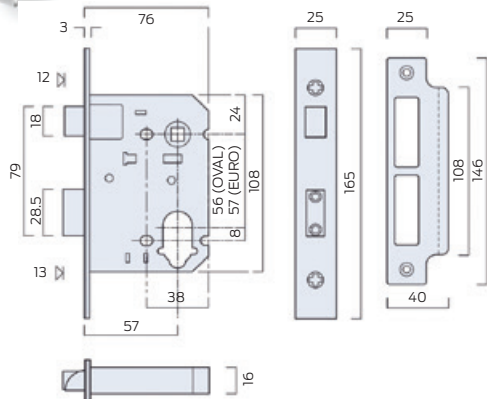
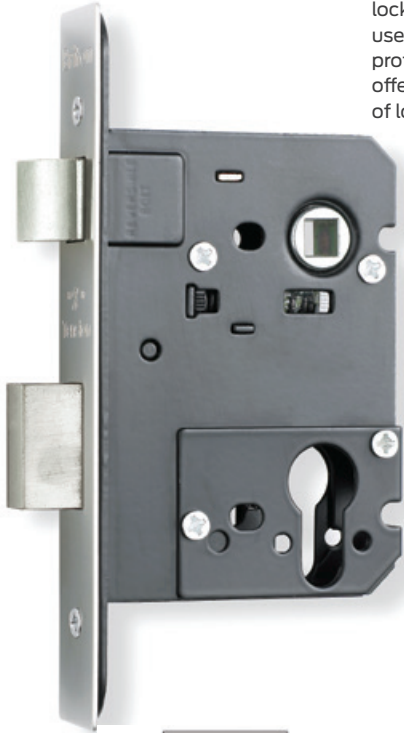

**Briton 5210 Series**

**Dual Profile Cylinder Deadlock**

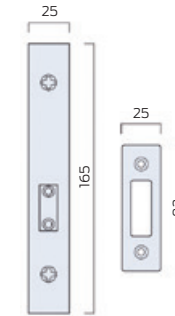

Lock dimensions shown on page 74

**Additional Features**

- Deadbolt can be operated from one side or both as required depending on the cylinder selected
- For use on doors without lever furniture
- 13mm deadbolt is thrown with a single turn of the cylinder



Item Ref:	Description	EN Classification	Centres	Backset	Finishes
5210.57.S	Mortice dual profile cylinder deadlock - square forend	3X810F2BA00	n/a	57mm	SS

**Briton 5220**

**Dual Profile Cylinder Sashlock**



Lock dimensions shown on page 74

**Additional Features**

- For lockable doors with lever furniture to withdraw the latchbolt
- 13mm single throw deadbolt
- Deadbolt can be operated from one side or both as required depending on the cylinder selected



Item Ref:	Description	EN Classification	Centres	Backset	Finishes
5220.57.S	Mortice dual profile cylinder sashlock - square forend	3X810F2BA20	57mm	57mm	SS

**Briton 5230 Bathroom Lock**



**Additional Features**

- For use on bathroom doors and those requiring a privacy function
- Latch retracted by lever handles
- 13mm throw deadbolt thrown by thumbturn & emergency release (5mm turn follower)



Lock dimensions shown on page 74

Item Ref:	Description	EN Classification	Centres	Backset	Finishes
5230.57.S	Mortice bathroom lock - square forend	3X810F-B020	57mm	57mm	SS

**Briton 5250 Series Dual Profile Cylinder Nightlatch**



**Additional Features**

- Nightlatch function operated by a half set of levers, with the lever on the inside to retract the latchbolt.
- Single cylinder on the outside operates the latchbolt with a single key turn
- Anti-thrust feature prevents manipulation of the latchbolt when the door is closed



Lock dimensions shown on page 74

Item Ref:	Description	EN Classification	Centres	Backset	Finishes
5250.57.S	Dual profile nightlatch - square forend - with hold-back	not CE marked	*	57mm	SS; PB
* for euro profile cylinder centres are 47.6mm and for oval cylinders centres are 48mm					

**Briton 5240 Latch**

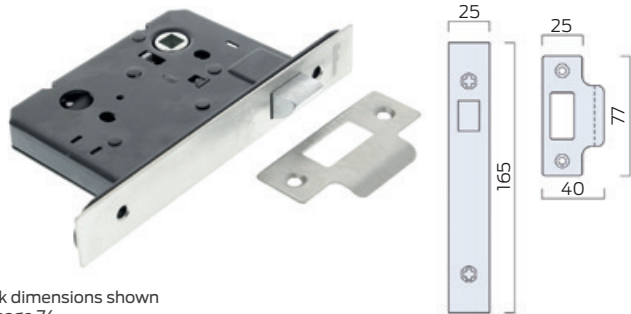

**Additional Features**

- Suitable for use with lever furniture on doors that do not need to be locked



Lock dimensions shown on page 74

Item Ref:	Description	EN Classification	Centres	Backset	Finishes
5240.57.S	Mortice latch - square forend	3X810F-B020	n/a	57mm	SS

## Home security - a simple guide to what products to use where

It is worth remembering that 8 out of 10 burglaries are committed by opportunist thieves – in fact in 20% of cases, the burglar enters through a door or window that has been left open. Burglars are always on the lookout for an easy target so a few simple and cost effective precautions will help to put them off.



### Door security

Most front doors are fitted with a **nightlatch**, which latches automatically when the door is closed, but can be opened from inside without a key. These provide a measure of security but can be forced by thieves so shouldn't be relied upon on their own.

All external doors should be fitted with a kitemarked lock or nightlatch certified to BS 3621. For timber doors we would recommend a BS 5 lever mortice deadlock or a sashlock. A door fitted with one of these can only be opened with a key, so a thief can't smash a glass panel or climb in through a window to open it from the inside.

An extra measure of security can be provided by fitting rack or tube bolts, top and bottom, to all exterior doors.

### Perimeter security

Garden theft is on the rise and sheds and garages can also be vulnerable.

A strong, lockable gate fitted across a side passage will prevent a thief getting to the rear of a property. These can be secured using a rim lock or padlock and hasp.

Fit shed and garage doors with a strong padlock and hasp. Where there is a connecting door to the house this should be treated as an external door and fitted with a BS kitemarked lock.

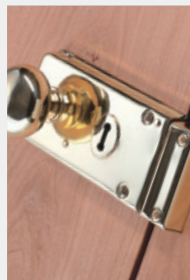

## Residential entrance security

### Timber Door Construction

The door itself should be at least 44mm thick and constructed of solid timber with any panels a minimum of 14mm thick. The door frame must be solid and securely fixed to the walls at least every 600mm around the whole frame.

Any glass panels should be laminated security glass or have a metal grid or polycarbonate shield on the inside.

### Door Hardware

The hardware fitted to the door can have a significant effect on security and as a consequence this can reduce the cost of some insurance policies. Please ensure you check the particulars of your own policy.

1. A good quality automatic deadlocking nightlatch should be fitted approximately 1/3 of the way down the door.
2. A good quality 5 lever mortice deadlock should be fitted approximately 1/3 of the way up the door. This should be a kitemarked lock to BS3621:2007 + A2:2012.
3. A door viewer allows the occupant to see who is at the door before opening the door.
4. A door chain allows the occupant to check who is calling without having to fully open the door.

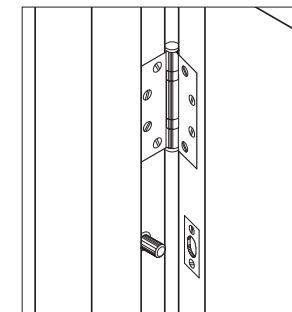
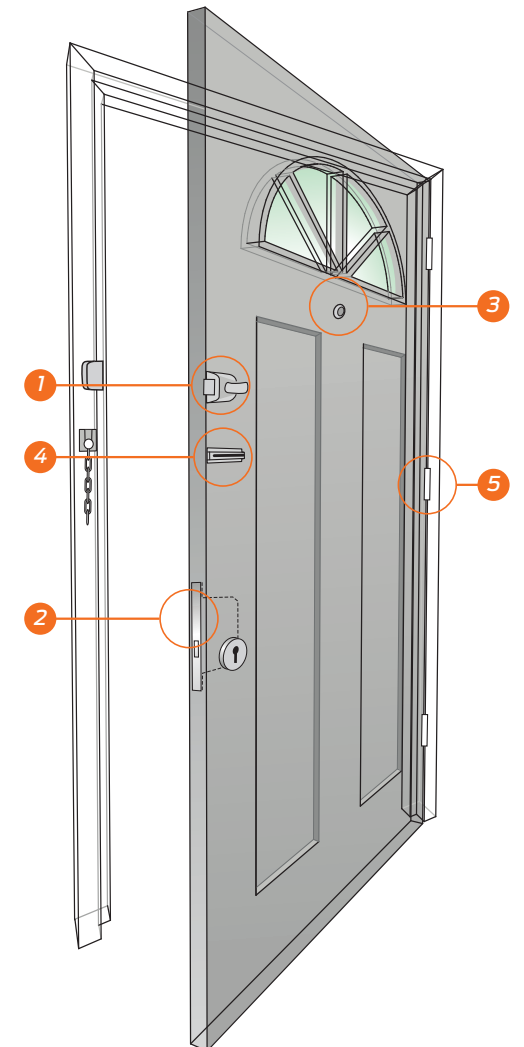

### 5. Hinges



The door should be fitted with at least three, 100mm hinges. The hinges should be selected to suit the weight of the door and are generally available to suit different door thicknesses. The hinges should be in accordance with BS EN 1935.

### Hinge Bolts

It is recommended to fit two or three hinge bolts midway between the hinges. These are essential if the door opens outwards as it prevents the door being opened by cutting or grinding off the hinge knuckles.



Which Lock? - a simple guide to lock selection

	High Security		Low Security			
	BS 5 Lever Sashlock	BS 5 Lever Deadlock	2 Lever Sashlock	Nightlatch	Rim Lock	Bathroom Lock
Typical Applications	Back door Period door	Front door Period door	Internal door	Front door	Internal door Period door Shed door	Bathroom door
Choose from these products	N5642 N5762	N5641 N5761	159 2378	707 727	2136 2143	B3751/2.5 B3751/3.0
	 BS 3621:2007 Licence KM662	 BS 3621:2007 Licence KM662			2144	



BS 3621:2007  
Licence KM662

Mortice locks can either be operated by a cylinder (see commercial lockcases) or by integral levers. In the case of lever locks the higher the number of levers, the more security the lock provides. Most insurance companies require that external timber doors are secured by a British Standard 5 lever mortice lock or mortice nightlatch. Look for the Kitemark when specifying and purchasing products. Internal doors and those on outbuildings can be secured by a 2 or 3 lever lock, but these will not offer the same level of security as a BS 5 lever kitemarked lock.

**Sashlock**

Has 2 bolts, a key operated deadbolt and a separate handle operated latchbolt. Ideal for use on doors which are in frequent use and which can be locked.



**Deadlock**

Has a key operated deadbolt and is mainly used for securing main entrance doors as additional security when using a rim nightlatch.



**Bathroom Lock**

A mortice lock for use on doors where privacy is required. Should be used with bathroom door furniture.



Legge Locks

**Twist reversible latch bolt**

To assist you in the selection and installation process all our platform range of mortice lever locks incorporate this feature, which offers a fast and easy way of reversing the hand of the latch in seconds, without the need to open the lockcase. This means that you do not need to know the hand of the door when selecting your lock.

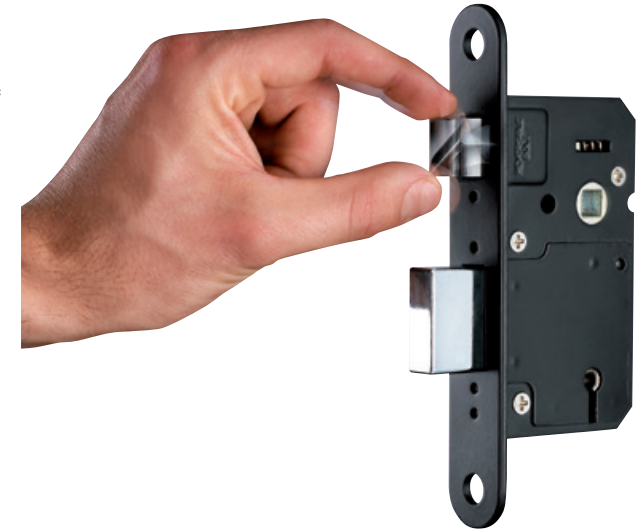

If you are replacing an existing mortice lockcase you can find out the size you require by:

1. Simply measuring from the centre of the keyhole to the forend of the lock. - this gives you the backset measurement.
2. Measuring the distance between the edge of the case and the edge of the forend - this gives you the case size.

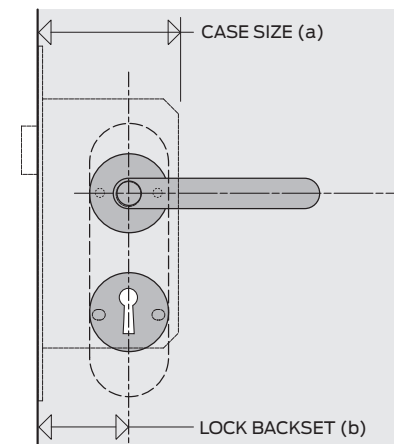

Legge Platform Series BS 5 Lever Locks

General Description

Legge BS 5 lever lockcases offer exceptional levels of attack resistance making them an ideal choice for domestic and commercial applications.

Principal Features

- A range of Kitemarked BS 5 lever sashlocks and deadlocks
- Suitable for bolt through furniture fixings at 38mm centres
- Testing: CE Marked to EN 12209 Grade 7 Fully compliant with BS361:2007 and kitemarked Fire tested to EN 1634 on timber and composite doors to achieve 1 hour fire rating, and 4 hour steel doors.
- Guarantee: 10 years (BS 5 lever locks)



Finishes

Available with plated finish stainless steel or polished brass forend and matching strike plate



Sashlock

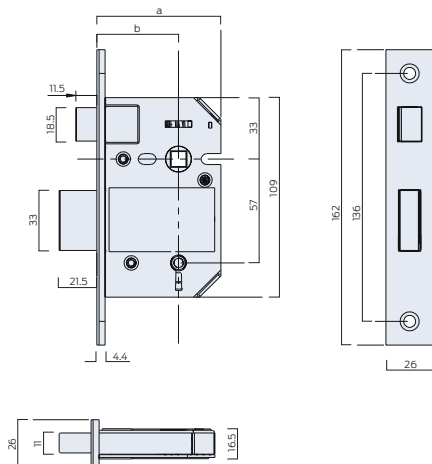

Deadlock

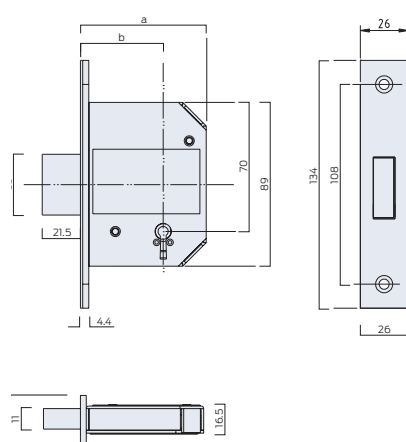

Dimensions (a) case size and (b) backset are detailed for each lock in the product tables

Legge Platform Series BS 5 Lever Locks

Additional Features

- Kitemarked BS 3621:2007
- 20mm deadbolt throw
- Anti-pick and anti-drill protection
- 'Pull and Twist' reversible latchbolt
- Hardened steel anti-saw deadbolt
- Steel case, black powder coated finish
- 3 plated steel keys



(AG5127) - sashlocks  
(AG5126) - deadlocks

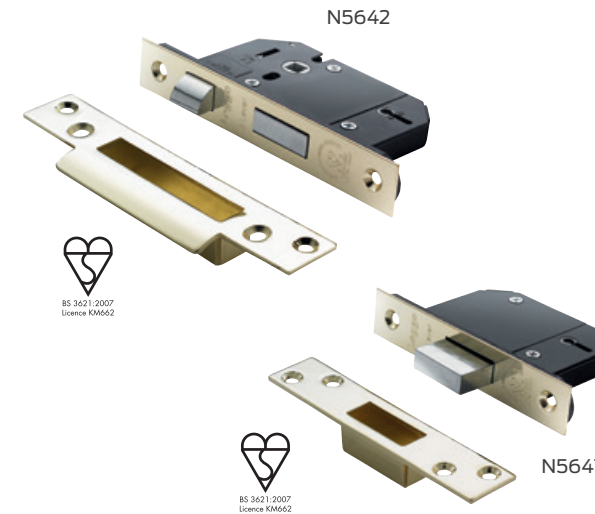

Item Ref:	Description	CE Classification	Case Size (a)	Backset (b)	Finishes
N5641	Deadlock - EN 12209 & CE marked	2M810F7KD0B	68mm	45mm	SS; PB
N5761	Deadlock - EN 12209 & CE marked	2M810F7KD0B	81mm	58mm	SS; PB
N5642	Sashlock - EN 12209 & CE marked	2M810F7KD2B	68mm	45mm	SS; PB
N5762	Sashlock - EN 12209 & CE marked	2M810F7KD2B	81mm	58mm	SS; PB

Legge Non Platform 2 Lever Locks

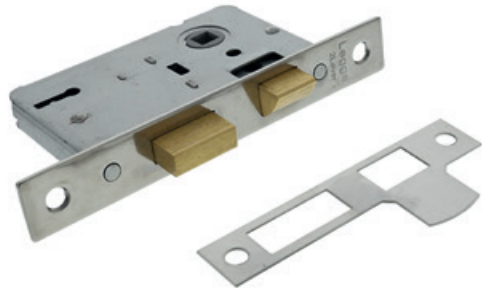

- Principal Features**
- 2 brass levers
  - 8mm high strength Zytel follower
  - 24 differs
  - Brass deadbolt
  - Reversible latch for site handing
  - 2 die cast keys
  - 5 year guarantee



Item Ref:	Description	Case Size (a)	Backset (b)	Finishes
B159	2 Lever sashlock	64mm	44mm	NP; PB
B2378	2 Lever sashlock	76mm	57mm	NP; PB

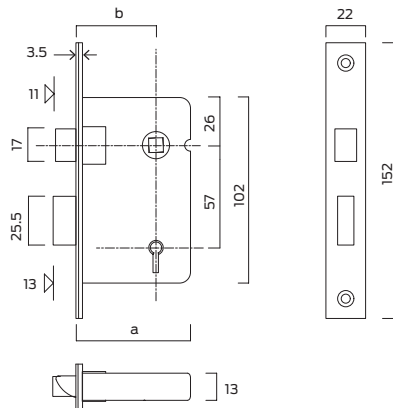

Legge Non Platform Bathroom Locks

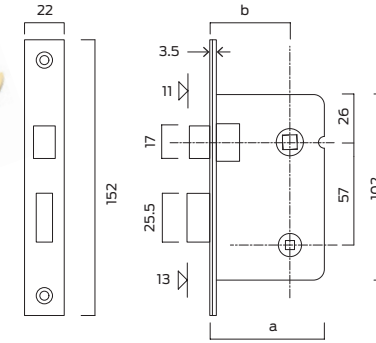

- Principal Features**
- Brass deadbolt
  - Reversible latch for site handing
  - Suitable for bolt through fixings at 38mm centres
  - 5 year guarantee



Item Ref:	Description	Case Size (a)	Backset (b)	Finishes
B3751/2.5	Bathroom lock	64mm	44mm	NP; PB
B3751/3.0	Bathroom lock	76mm	57mm	NP; PB

Legge Non Platform Bathroom Deadbolt

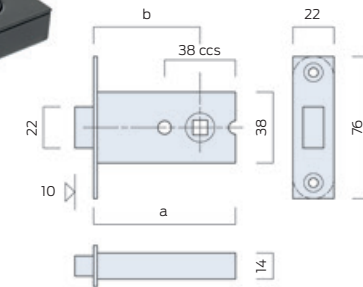

- Principal Features**
- Brass deadbolt with thumbturn operation
  - Suitable for bolt through fixings at 38mm centres
  - 5mm or 8mm bathroom function follower
  - Round or square ended forend
  - 3 year guarantee



Item Ref:	Description	Case Size (a)	Backset (b)	Finishes
B2512/5	Bathroom deadbolt with 5mm thumbturn follower	76mm	57mm	SS; PB
B2512/8	Bathroom deadbolt with 8mm thumbturn follower	76mm	57mm	SS; PB

Legge Latches

Mortice Latches



Principal Features

- Meets the requirements of EN 12209 (B3708)
- CE marked (B3708)
- Suitable for bolt through fixings at 38mm centres
- 8mm high strength follower
- 5 year guarantee



(AG0043)

Item Ref:	Description	CE Classification	Case Size (a)	Backset (b)	Finishes
B3708	Mortice latch - EN 12209 & CE	NPD H810F-B010	64mm	44mm	NP; PB
B3709LK	Mortice latch	n/a	76mm	60mm	NP; PB

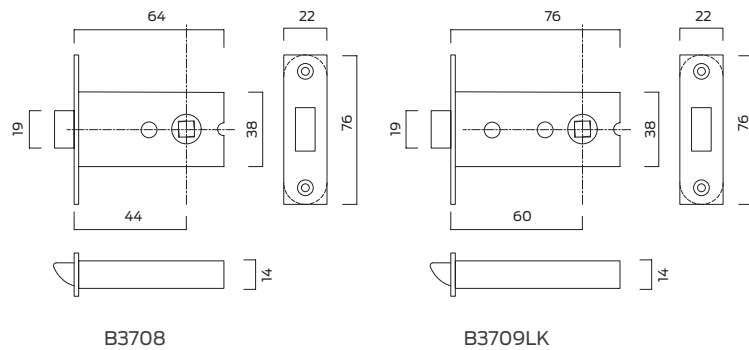

Legge Latches

Tubular Latches

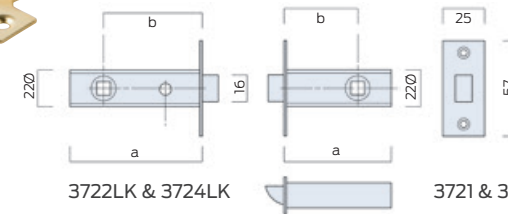

Principal Features

- Meets the requirements of EN 12209 (B3721 & B3722)
- CE marked (B3721 & B3722)
- 8mm high strength follower
- Lifetime guarantee



(AG0043)

Item Ref:	Description	CE Classification	Case Size (a)	Backset (b)	Finishes
B3721	Tubular latch - EN 12209 & CE	NPD H810F-B010	64mm	44mm	NP; PB; EB
B3722	Tubular latch - EN 12209 & CE	NPD H810F-B010	76mm	60mm	NP; PB; EB
B3724LK	Tubular latch - Lockable	n/a	95mm	76mm	NP; PB; EB

Legge Latches

Roller Latch

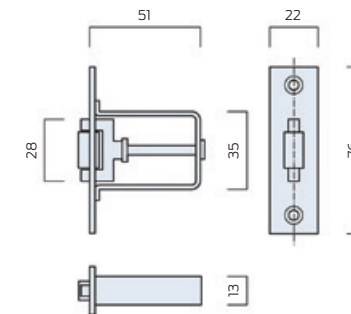
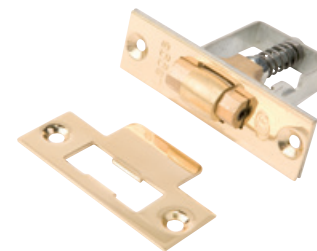

Principal Features

- Brass latch
- Adjustable to provide a positive push/pull operation
- 3 year guarantee

Item Ref:	Description	Case Size (a)	Backset (b)	Finishes
B1511	Roller latch	51mm	n/a	SS; PB

Legge Locks

Rebate Sets

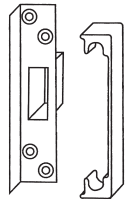

B41

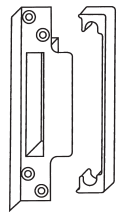

B42

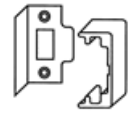

B21

General Description

A series of rebate sets to enable the installation of Briton mortice locks and latches into rebated doors.

Principal Features

- Available to suit 12.5mm or 25mm rebate
- PB & SS finishes as standard (except B21)

Item Ref:	Description	B3751/2.5	B3751/3.0	3721 / 3722	3722LK / 3724LK	N5641 / N5761	N5642 / N5762	Finish
B21	Rebate set - 12.5mm			✓	✓			PB; NP
N41/0.5	Rebate set - 12.5mm					✓		PB; SCP
N42/0.5	Rebate set - 12.5mm	✓	✓				✓	PB; SCP

Secondary Security

Rack Bolt

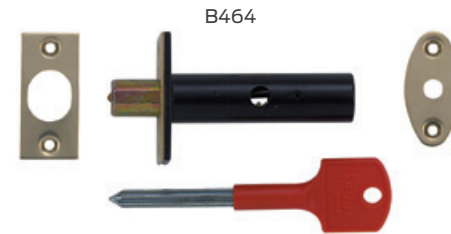

B464

Principal Features

- Morticed bolt suitable as additional security
- When fitted bolt is not seen from outside
- Operated by key from inside
- Recommend one bolt is used top and bottom of a door

Item Ref:	Description	Finishes
B464	2 Rack bolts with 1 key	SS; PB
B465	2 Rack bolt keys only	Miscellaneous

**Rim Nightlatches**

Most front doors are fitted with a rim nightlatch, which locks automatically when the door is closed, but can be opened from the inside without a key. Most can be deadlocked by a snib from inside or by turning the key from the outside. These provide a measure of security but can be forced by thieves so shouldn't be relied upon on their own. On external doors they must always be used in combination with a BS kitemarked lock.

Our Briton range of nightlatches provides a series of surface mounted nightlatches with both deadlocking and non deadlocking functions. These are suitable for use on inward and outward opening doors (separate strike plates will be required for outward opening doors).

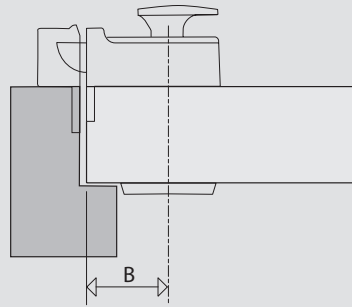

When selecting a replacement nightlatch, it is important to check that the backset (B) (ie. the measurement from the centre of the keyhole to the edge of the door) is the same as your existing lock. If you are fitting a lock to a new door, choose the longest backset that allows a comfortable fit.

**Rim Locks**

A surface mounted rim lock should only be used where a high level of security is not required. Rim locks are ideal for internal doors, particularly in period properties or gates and outbuildings.

Our Briton range also includes a selection of knobs with 8mm spindles to operate our rim locks.



**Legge 707 & 727**

**Multifunction Rim Nightlatches**

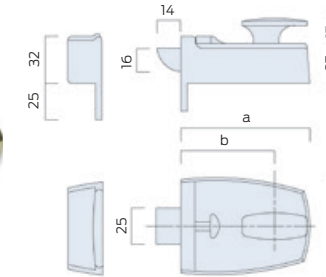

**Principal Features**

- Brass latchbolt
- Suitable for most retrofit applications
- Clockwise or anti-clockwise knob operation to withdraw latch
- Latch and knob are rendered inoperative by the deadlocking function
- Supplied with 5 pin rim cylinder
- Guarantee: 3 years

Item Ref:	Description	Case Size (a)	Backset (b)	Finishes
707	Rim nightlatch with deadlocking function	89mm	60mm	PB/BP; PB/SV
727	Rim nightlatch with deadlocking function	73mm	44mm	PB/BP; PB/SV

Legge Rim Locks

Rim Locks & Latches



B472/2.0

General Description

A series of rim locks and latches which are surface mounted, typically onto period doors, sheds or garages. Locks and latches should be used in conjunction with the knob furniture which must be selected separately.

Principal Features

- Rim lock with latch and deadbolt
- Suitable for knobs with 8mm spindles
- Brass latch and deadbolt
- Locks have 12 differs and are supplied with 2 keys
- Guarantee: 3 years

Knob Furniture

- Knob furniture for use with Briton rim locks and latches
- Supplied with 2 covered escutcheons
- Sold as pairs



B2144 Rim Deadlock

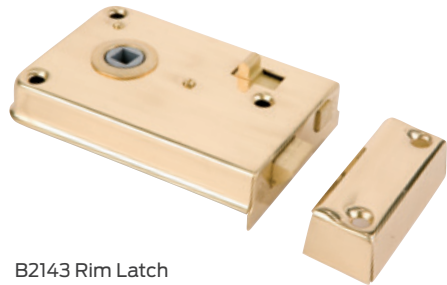

B2143 Rim Latch



B2136 Rim Lock

Legge Rim Locks

Rim Locks & Latches

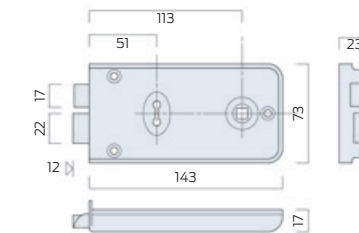

Briton 2136

- Rim latch
- Suitable for knobs with 8mm spindles
- Deadbolt operated by lever key

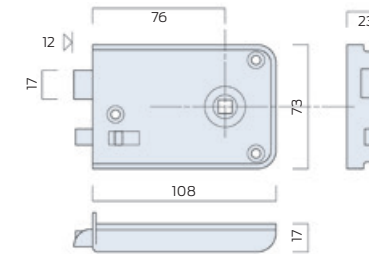

Briton 2143

- Rim latch
- Suitable for knobs with 8mm spindles
- Deadbolt operated by inside snib

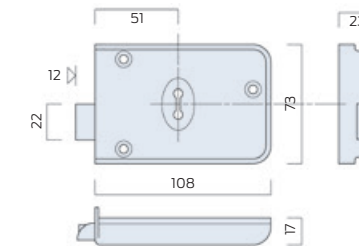

Briton 2144

- Rim deadlock operated by lever key
- Brass deadbolt

Item Ref:	Description	Case Size	Key backset	Knob backset	Finishes
B2136	Rim lock with latch and deadbolt	143mm	51mm	113mm	PB; BM
B2143	Rim latch with internally operated deadbolt	108mm	-	76mm	PB; BM
B2144	Rim deadlock - key operated	108mm	51mm	-	PB; BM
B472/2.0	Knob furniture - 51mm Victorian domed	n/a	n/a	n/a	PB
B472/2.25	Knob furniture - 57mm Victorian domed	n/a	n/a	n/a	PB

## Cylinders

Cylinder locks are a very flexible and sophisticated means of providing security on most doors and have a number of advantages over other methods of door locking. They give you the ability to:

- Select the most appropriate lockcase and cylinder combination
- Match the level of security to the precise needs of each door in a building
- Upgrade security levels as the needs of the building or its occupants change
- Provide sophisticated masterkeying and key control where access to multiple doors can be restricted to specific personnel

## Patent Protection on cylinders

Since copyright protection on keys was abolished it is now possible for anybody to produce and sell most types of keys. The only systems that can truly protect against illegal keyblank duplications are patented key systems. Manufacturers can take legal action against any third parties who distribute copies of patented keys without permission.

The Briton 75-29 range is patent protected until 2029, thus ensuring the highest possible levels of security and patent protection for all.

## Cylinders - The CISA and Briton Range

Both the CISA and Briton ranges of cylinders include euro and oval profiles, which can be supplied either standard differ, keyed alike or masterkeyed. This catalogue focuses on euro profile cylinders as they make up the majority of the UK market. For further information on our complete range of cylinders contact us on: 0330 8080 617.

## Addressing physical security

An intruder seeking to break open a door will in most cases choose to "attack" the lock cylinder. Methods of protecting against forced entry are 'defensive' features of passive security.

### 1 - Push resistance

A projecting cam on the cylinder can prevent it from being forced out of the lockcase by a hammer blow.

### 2 - Drill resistance

The incorporation of steel pins within the cylinder are designed to resist or delay attacks from drilling.

### 3 - Pick resistance

Special pin configurations can resist the manipulation of the pins in an attempt to simulate the key.

### 4 - Snap resistance

The inclusion of hardened steel laminates within the body of the cylinder can prevent violent twisting and snapping of the cylinder.

### 5 - Bump resistance

Bumping of cylinders is becoming more of an issue throughout Europe, particularly as there is no sign of forcible entry for homeowners to claim on insurance.

## Bumping and Snapping

Bumping and snapping are the prevalent forms of cylinder attack sweeping across Europe. The problem is being exacerbated by internet sites spreading the word amongst the criminal community.

We pride ourselves on being at the forefront of the market with our CISA cylinders and we are able to offer tried and tested cylinders to provide protection from just these kinds of attack. Our Astral ranges incorporate features designed to make them bump and snap resistant.

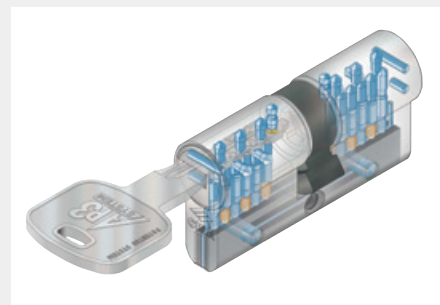

## What is the right length of cylinder?

Selecting the right length of cylinder is important not only for aesthetic reasons but also:

- To limit the amount of cylinder that projects from the face of the door hardware in order to protect it from attack by twisting and snapping
- To avoid the risk of hitting the cylinder with the hand when using lever handles

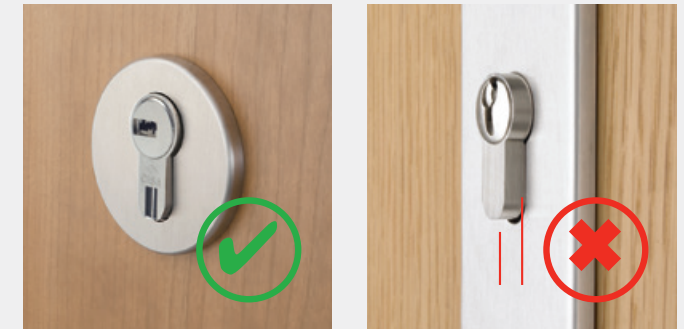

## Selecting the correct cylinder length

Specifying the correct cylinder length is important not only for aesthetic reasons, but also for security. The cylinder must be fitted as flush as possible with the surrounding hardware in order to reduce the opportunity for the cylinder to be removed.

When choosing a cylinder, three factors should be considered:

- Thickness of door
- Thickness of hardware, eg. Escutcheons or backplate
- Position of the lock within the door

The overall length of the cylinder should be just larger than the combined thickness of the door  $D$  (see diagram below) and the backplates or escutcheons ( $D + 2X$ ).

When using a thumbturn, an additional 2mm clearance is recommended.

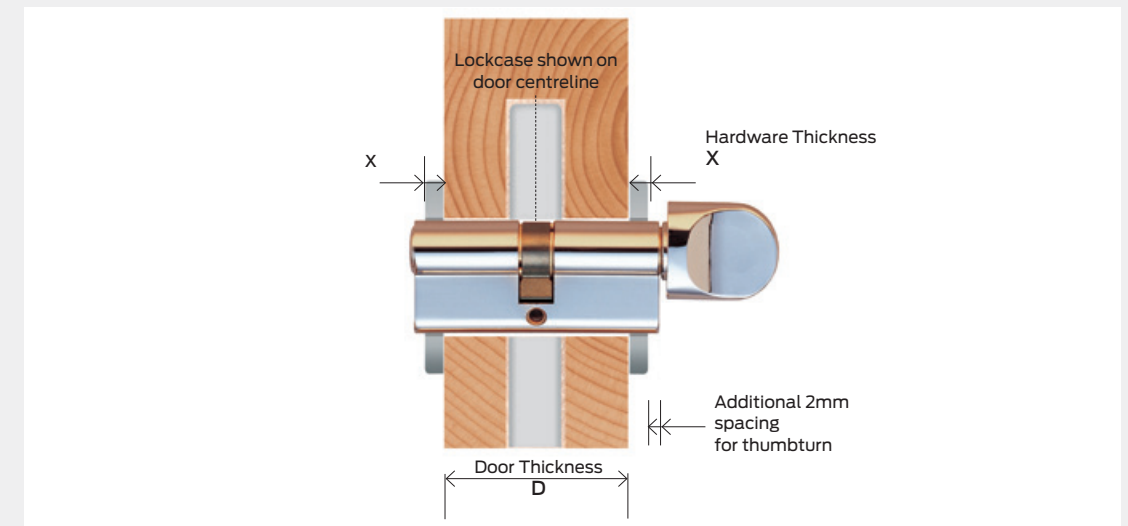



Cylinder Selector



Features and options	CISA Astral S	CISA Astral	Briton C2000	Briton 75-29
<b>Performance Level</b>	<b>Level 4</b>	<b>Level 3</b>	<b>Level 2</b>	<b>Level 3</b>
No. of pins	10 pin	10 pin	5	6 + check pin
Push resistant projecting cam	■	■	■	■
Anti-pick pins	■	■	■	■
Anti-drill	■	■	■	■
Bump resistant	■			
Snap resistant	■			
Patent protection				up to 2029
Protected key duplication	■	■		■
Key duplication by code card	■	■		
No. of differs	1.6 million	1.6 million	30,000	30,000
Masterkeying capacity	up to 63,000 keys	up to 63,000 keys	up to 1,000 keys	TBA*
<b>EN 1303:2005 Classification</b>	<b>16 010 C 62</b>	<b>16 010 C 60</b>	<b>16 010 C 40</b>	<b>16 000 C 52</b>
<b>Kitemarked TS007:2012</b>	■			
Anti-barricade function	□	□		□
Classroom function	□	□	□	□
Construction keying function	□	□		□
<b>Cylinder Types</b>				
Euro profile	■	■	■	■
Oval profile				■
Rim		■	■	■
Rim mortice/threaded		■		■

\* Dependent on the complexity of the masterkey system

■ Standard □ Available as an option/variant

CISA Astral S Series - Anti-Snap & Bump Resistant Cylinders



General Description

Traditional cylinders used in most PVCu doors are open to attack from unscrupulous thieves, who are using the internet to spread the word on how to attack them.

CISA has a cylinder range to combat this ever increasing problem and provide levels of high security and protection against these methods of attack. CISA Astral S cylinders have a unique visual snap resistant core, which has been designed to deter thieves from trying to attack the lock and thus prevent damage to the door.

Astral S cylinders are kitemarked to TS0071 Star. TS007 is aimed at the retrofit market, and has been introduced specifically to address the vulnerabilities of lock cylinders. The standard, which uses a star rating, has been created to offer protection against cylinder snapping, bumping and other methods of access. The new standard is designed as a three star solution. Under the ratings, a three star solution can be achieved by a combination of a cylinder (marked with 1 star ie: Astral S) and security door furniture such as a strengthened door handle (marked with two stars).

For added convenience the Astral S cylinders are completely interchangeable with the standard Astral range allowing them to be used specifically where increased security is required.

The drawing below shows you the added protection we have incorporated into the range.

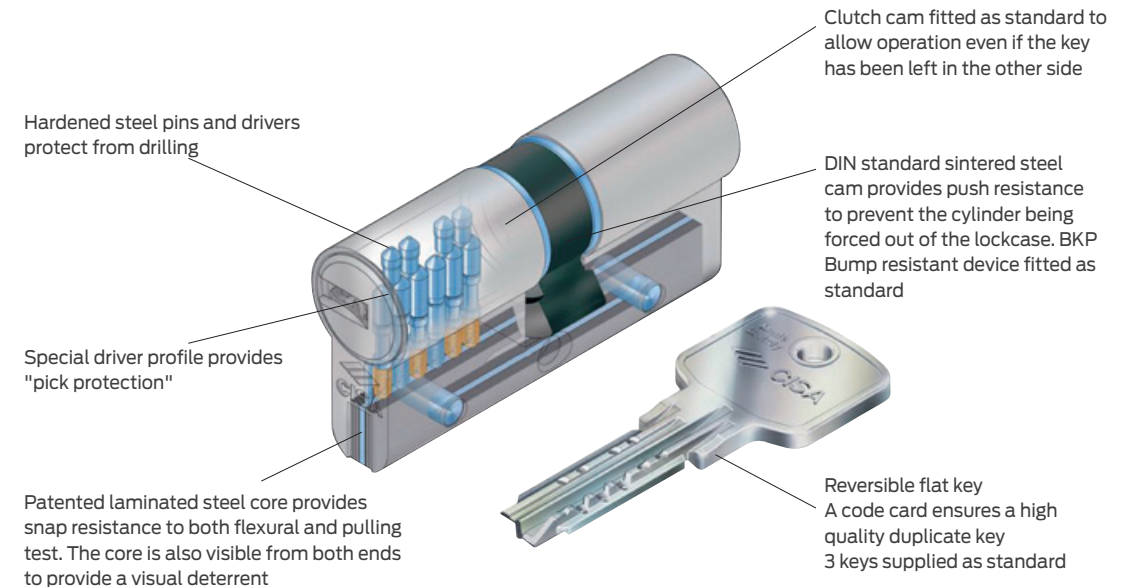

CISA Astral S Series

Medium Security Euro Profile Cylinders



TS007:2012  
Licence KM532990



General Description

CISA Astral S is a range of kitemarked cylinders that have been designed to offer protection from the most common forms of attack.

Principal Features

- Ideal for commercial and residential applications
- Patented laminated steel snap resistant core
- BKP Bump resistant device fitted as standard
- Hardened steel pin and driver protect from drilling
- Pick resistant profiled brass pins and drivers
- 10 pin key biting system offers over 1.6 million key differs
- DIN standard sintered steel cam provides push resistance to prevent the cylinder being forced out of the lockcase
- Clutch cam as standard
- Reversible flat key (3 keys supplied as standard)

Testing:

EN 1303:2005 compliant  
Grade 2 drilling & torque resistance  
Grade 1 attack resistance  
Grade 6 durability  
Grade 6 key security  
Kitemarked to TS007:2012- 1 Star (KM532990)  
ICIM EN1303:2005 (16010C62)

- Guarantee: 2 years



Standard & Offset Cylinders

The Astral S range comprises euro profile cylinders in standard and offset double as well as standard and offset double with thumbturn in a wide selection of lengths and offsets.

For more information call our Customer Care Team on - 0330 8080 617

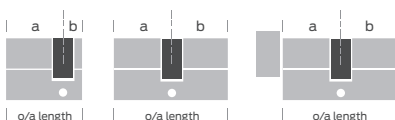

Item Ref:	Description	Size	Finishes
OA3S1.07	Astral S Euro profile double cylinder	30/30mm	SB; NP
OA3S1.13	Astral S Euro profile double cylinder	35/35mm	SB; NP
OA3S1.18	Astral S Euro profile double cylinder	40/40mm	SB; NP
OA3S1.23	Astral S Euro profile double cylinder	50/50mm	SB; NP
OA3S1.29	Astral S Euro profile double cylinder	45/45mm	SB; NP

CISA Astral S Series

Medium Security Euro Profile Cylinders

Item Ref:	Description	Size	Finishes
OA3S1.12	Astral S Euro profile double cylinder - Offset	30/40mm	SB; NP
OA3S1.17	Astral S Euro profile double cylinder - Offset	30/50mm	SB; NP
OA3S1.19	Astral S Euro profile double cylinder - Offset	35/45mm	SB; NP
OA3S1.20	Astral S Euro profile double cylinder - Offset	30/60mm	SB; NP
OA3S1.21	Astral S Euro profile double cylinder - Offset	40/50mm	SB; NP
OA3S1.25	Astral S Euro profile double cylinder - Offset	40/60mm	SB; NP
OA3S1.28	Astral S Euro profile double cylinder - Offset	35/40mm	SB; NP
OA3S1.30	Astral S Euro profile double cylinder - Offset	40/45mm	SB; NP
OA3S1.31	Astral S Euro profile double cylinder - Offset	35/50mm	SB; NP
OA3S1.32	Astral S Euro profile double cylinder - Offset	35/55mm	SB; NP
OA3S1.39	Astral S Euro profile double cylinder - Offset	45/50mm	SB; NP
OA3S1.42	Astral S Euro profile double cylinder - Offset	40/55mm	SB; NP
OA3S1.43	Astral S Euro profile double cylinder - Offset	45/55mm	SB; NP
OA3S2.07	Astral S Euro profile cylinder and thumbturn	30/30mm	SB; NP
OA3S2.13	Astral S Euro profile cylinder and thumbturn	35/35mm	SB; NP
OA3S2.18	Astral S Euro profile cylinder and thumbturn	40/40mm	SB; NP
OA3S2.23	Astral S Euro profile cylinder and thumbturn	50/50mm	SB; NP
OA3S2.29	Astral S Euro profile cylinder and thumbturn	45/45mm	SB; NP
OA3S2.19	Astral S Euro profile cylinder and thumbturn - Offset	35/45mm	SB; NP
OA3S2.21	Astral S Euro profile cylinder and thumbturn - Offset	40/50mm	SB; NP
OA3S2.42	Astral S Euro profile cylinder and thumbturn - Offset	40/55mm	SB; NP
OA3S2.43	Astral S Euro profile cylinder and thumbturn - Offset	45/55mm	SB; NP
OA3S2.84	Astral S Euro profile cylinder and thumbturn - Offset	45/40mm	SB; NP
OA3S2.85	Astral S Euro profile cylinder and thumbturn - Offset	45/35mm	SB; NP

Item Ref:	Description
M.OA.M	Astral S Master Keys
KEY.OA	Astral S Extra Servant (Differ) Keys Ordered Later
M.OA.D	Astral S Extra Servant (Differ) Keys Supplied With Order

CISA Astral Series

Medium Security Euro Profile Cylinders



General Description

Astral cylinders are the ultimate convenience solution for masterkeying with up to 63,000 different cylinders on a single system.

Principal Features

- Ideal for use on small commercial access management applications
  - Suitable for Briton 5600, 5500, 5400 and 5200 Series lockcases
  - Up to 63,000 cylinders per system
  - Hardened steel pin and driver in first position protect from drilling
  - Pick resistant profiled brass pins and drivers
  - 10 pin key biting system offers over 1.6 million key differs
  - DIN standard sintered steel cam provides push resistance to prevent the cylinder being forced out of the lockcase
  - Reversible flat key (3 keys supplied as standard)
  - Code card required for key duplication
- 
- Testing: EN 1303:2005 compliant  
Grade 6 durability  
Grade 6 key security  
Grade 0 attack resistance
- 
- Guarantee: 2 years

Standard & Offset Cylinders

The Astral range comprises euro profile cylinders in single, standard and offset double as well as standard and offset double with thumbturn in a wide selection of lengths and offsets. The range is also available in rim, UK oval profile and rim mortice cylinder options.

For more information call our Customer Care Team on - 0330 8080 617

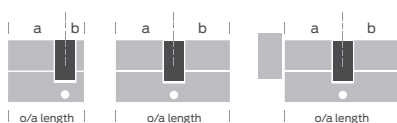

Item Ref:	Description	Size	Finishes
OA310.07	Astral Euro profile double cylinder	30/30mm	SB; NP
OA310.13	Astral Euro profile double cylinder	35/35mm	SB; NP
OA310.18	Astral Euro profile double cylinder	40/40mm	SB; NP
OA310.23	Astral Euro profile double cylinder	50/50mm	SB; NP
OA310.29	Astral Euro profile double cylinder	45/45mm	SB; NP
OA310.12	Astral Euro profile double cylinder - Offset	30/40mm	SB; NP
OA310.17	Astral Euro profile double cylinder - Offset	30/50mm	SB; NP
OA310.19	Astral Euro profile double cylinder - Offset	35/45mm	SB; NP

CISA Astral Series

Medium Security Euro Profile Cylinders

Item Ref:	Description	Size	Finishes
OA310.20	Astral Euro profile double cylinder - Offset	30/60mm	SB; NP
OA310.21	Astral Euro profile double cylinder - Offset	40/50mm	SB; NP
OA310.25	Astral Euro profile double cylinder - Offset	40/60mm	SB; NP
OA310.28	Astral Euro profile double cylinder - Offset	35/40mm	SB; NP
OA310.30	Astral Euro profile double cylinder - Offset	40/45mm	SB; NP
OA310.31	Astral Euro profile double cylinder - Offset	35/50mm	SB; NP
OA310.32	Astral Euro profile double cylinder - Offset	35/55mm	SB; NP
OA310.42	Astral Euro profile double cylinder - Offset	40/55mm	SB; NP
OA310.43	Astral Euro profile double cylinder - Offset	45/55mm	SB; NP
OA312.07	Astral Euro profile cylinder and thumbturn	30/30mm	SB; NP
OA312.13	Astral Euro profile cylinder and thumbturn	35/35mm	SB; NP
OA312.18	Astral Euro profile cylinder and thumbturn	40/40mm	SB; NP
OA312.19	Astral Euro profile cylinder and thumbturn - Offset	35/45mm	SB; NP
OA312.21	Astral Euro profile cylinder and thumbturn - Offset	40/50mm	SB; NP
OA312.42	Astral Euro profile cylinder and thumbturn - Offset	40/55mm	SB; NP
OA312.43	Astral Euro profile cylinder and thumbturn - Offset	45/55mm	SB; NP
OA312.84	Astral Euro profile cylinder and thumbturn - Offset	45/40mm	SB; NP
OA312.85	Astral Euro profile cylinder and thumbturn - Offset	45/35mm	SB; NP
OA314.02	Astral Euro profile single cylinder	30/10mm	SB; NP
OA314.03	Astral Euro profile single cylinder	40/10mm	SB; NP
OA314.07	Astral Euro profile single cylinder	35/10mm	SB; NP

Item Ref:	Description	Finishes
OA510.50	Astral Rim night latch cylinder	SB; NP
OA810.00	Astral single screw-in (threaded) cylinder	SB; NP

Item Ref:	Description
OA.KEY	Astral Extra Servant (Differ) Keys Ordered Later
M.OA.D	Astral Extra Servant (Differ) Keys Supplied With Order
M.OA.M	Astral Master Keys
CI.PASS.ASTRAL	Astral Keyed Alike Charge (Each Cylinder Side)

CISA C2000 Series

Basic Security & Masterkeying



General Description

For applications where strict control over key duplication is not such a high priority, the C2000 system offers a basic level of physical security but with the added convenience of local key cutting.



Principal Features

- Suitable for Briton 5600, 5500, 5400, and 5200 Series lockcases
  - Hardened steel pin and driver in the first position protect from drilling
  - Pick resistant profiled brass pins and drivers
  - 5 pin key biting system offers over 30,000 key differs
  - DIN standard sintered steel cam provides push resistance to prevent the cylinder being forced out of the lockcase
  - 3 keys supplied as standard
- 
- Testing: EN 1303:2005 compliant  
Grade 6 durability  
Grade 4 key security  
Grade 0 attack resistance
- 
- Guarantee: 2 years

Standard & Offset Cylinders

The C2000 range comprises euro profile cylinders in single, standard and offset double and standard as well as offset double with thumbturn in a wide selection of lengths and offsets. The system is also available in rim and rim mortice cylinder options.

For more information call our Customer Care Centre - 0330 8080 617

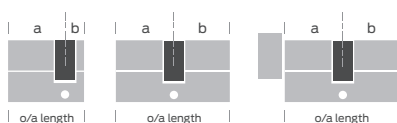

Item Ref:	Description	Size	Finishes
OG300.07	C2000 Euro profile double cylinder	30/30mm	SB; NP
OG300.13	C2000 Euro profile double cylinder	35/35mm	SB; NP
OG300.18	C2000 Euro profile double cylinder	40/40mm	SB; NP
OG300.23	C2000 Euro profile double cylinder	50/50mm	SB; NP
OG300.29	C2000 Euro profile double cylinder	45/45mm	SB; NP
OG300.12	C2000 Euro profile double cylinder - Offset	30/40mm	SB; NP
OG300.17	C2000 Euro profile double cylinder - Offset	30/50mm	SB; NP
OG300.19	C2000 Euro profile double cylinder - Offset	35/45mm	SB; NP

CISA C2000 Series

Basic Security & Masterkeying

Item Ref:	Description	Size	Finishes
OG300.20	C2000 Euro profile double cylinder - Offset	30/60mm	SB; NP
OG300.21	C2000 Euro profile double cylinder - Offset	40/50mm	SB; NP
OG300.25	C2000 Euro profile double cylinder - Offset	40/60mm	SB; NP
OG300.28	C2000 Euro profile double cylinder - Offset	35/40mm	SB; NP
OG300.30	C2000 Euro profile double cylinder - Offset	40/45mm	SB; NP
OG300.31	C2000 Euro profile double cylinder - Offset	35/50mm	SB; NP
OG300.32	C2000 Euro profile double cylinder - Offset	35/55mm	SB; NP
OG300.42	C2000 Euro profile double cylinder - Offset	40/55mm	SB; NP
OG300.43	C2000 Euro profile double cylinder - Offset	45/55mm	SB; NP
OG300.54	C2000 Euro profile double cylinder - Offset	45/60mm	SB; NP
OG302.07	C2000 Euro profile cylinder and thumbturn	30/30mm	SB; NP
OG302.13	C2000 Euro profile cylinder and thumbturn	35/35mm	SB; NP
OG302.18	C2000 Euro profile cylinder and thumbturn	40/40mm	SB; NP
OG302.19	C2000 Euro profile cylinder and thumbturn - Offset	35/45mm	SB; NP
OG302.21	C2000 Euro profile cylinder and thumbturn - Offset	40/50mm	SB; NP
OG302.42	C2000 Euro profile cylinder and thumbturn - Offset	40/55mm	SB; NP
OG302.43	C2000 Euro profile cylinder and thumbturn - Offset	45/55mm	SB; NP
OG302.84	C2000 Euro profile cylinder and thumbturn - Offset	45/40mm	SB; NP
OG302.85	C2000 Euro profile cylinder and thumbturn - Offset	45/35mm	SB; NP
OG304.02	C2000 Euro profile single cylinder	30/10mm	SB; NP
OG304.03	C2000 Euro profile single cylinder	40/10mm	SB; NP
OG304.07	C2000 Euro profile single cylinder	35/10mm	SB; NP

Item Ref:	Description	Finishes
OG500.50	C2000 Rim night latch cylinder	SB; NP
02900.00	C2000 single screw-in (threaded) cylinder	SB; NP

Item Ref:	Description
OG.KEY	C2000 Extra Servant (Differ) Keys Ordered Later
M.OG.D	C2000 Extra Servant (Differ) Keys Supplied With Order
M.OG.M	C2000 Master Keys
CI.PASS	Keyed Alike Charge (Each Cylinder Side)

Briton 75-29 Series

Basic Security & Masterkeying



**General Description**

A range of Euro profile and oval profile cylinders with patented key design to prevent unauthorised key duplication.

**Principal Features**

- Patented key profile prevents unauthorised duplication to 2029
- Drill and pick resistant
- Key blanks carry a lifetime warranty
- 'Through-cut' technology utilises a unique process to produce the patented undercut design
- 6 pin tumbler system with additional 'check pin' for extra security
- Raised plug with unique slotted face for improved aesthetics
- Additional functions include Classroom function, construction keying and anti-barricade function.
- 2 keys supplied as standard

- Testing: EN 1303:2005 compliant  
Grade 6 durability  
Grade 5 key security  
Grade 2 \* attack resistance

- Guarantee: 2 years

\* when used with a security escutcheon

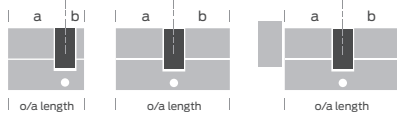

Item Ref:	Description	Size	Finishes
PXT45-K-ES40	Euro profile single cylinder	30/10mm	SB; NP
PXT45-K-ES45	Euro profile single cylinder	45/10mm	SB; NP
PXT45-K-ES50	Euro profile single cylinder	50/10mm	SB; NP
PXT45-K-ED60	Euro profile double cylinder	30/30mm	SB; NP
PXT45-K-ED70	Euro profile double cylinder	35/35mm	SB; NP
PXT45-K-ED80	Euro profile double cylinder	40/40mm	SB; NP
PXT45-K-ED45.45	Euro profile double cylinder	45/45mm	SB; NP
PXT45-K-ED50.50	Euro profile double cylinder	50/50mm	SB; NP

Briton 75-29 Series

Basic Security & Masterkeying

Item Ref:	Description	Size	Finishes
PXT45-K-ED35.45	Euro profile double cylinder - offset	35/45mm	SB; NP
PXT45-K-ED40.45	Euro profile double cylinder - offset	40/45mm	SB; NP
PXT45-K-ED40.50	Euro profile double cylinder - offset	40/50mm	SB; NP
PXT45-K-ED40.55	Euro profile double cylinder - offset	40/55mm	SB; NP
PXT45-K-ED45.55	Euro profile double cylinder - offset	45/55mm	SB; NP
PXT45-K-EST60	Euro profile cylinder & turn	30/30mm	SB; NP
PXT45-K-EST70	Euro profile cylinder & turn	35/35mm	SB; NP
PXT45-K-EST80	Euro profile cylinder & turn	40/40mm	SB; NP



Item Ref:	Description	Size	Finishes
PXT45-K-RC	Rim nightlatch cylinder	n/a	SB; NP

Item Ref:	Description
75-29 PASS	75-29 Keyed Alike Charge
75-29.KEY	75-29 Key Supplied Later
75-29.KEY.M	75-29 Master Key Supplied Later
M75-29.D	Briton 75-29 Differ Key Supplied With Order
M75-29.M	Briton 75-29 Master Key Supplied With Order
M75-29.BARRICADE	Anti Barricade Clutch Function
M75-29.CLASSROOM	Classroom Clutch Function

CISA Padlocks

CISA offer a wide range of padlocks covering all levels of security suitable for both commercial and residential use. They can be supplied individually keyed or keyed alike for increased convenience.

Shackle Type

The shackle is the u-shaped metal bar used to attach the lock to the hasp or chain. There are three styles of shackle shown below. When selecting your padlock it is important to consider the distance that you will have to secure the shackle into the lock. In principle, the shorter the shackle the less vulnerable the padlock is to attack.



Standard Length



Long Shackle



Slide Bolt

Application

All our padlocks are suitable for indoor use, however for outdoor use we recommend using a laminated or marine grade padlock to reduce the risk of corrosion. Our marine grade padlock has been designed specifically for locations close to the sea and has undergone a 1000 hour salt spray test.

CISA 28000 Series

Hardened Steel



28050

General Description

Provide a high level of attack resistance and strict control of key duplication.

Principal Features

- Range of shackle lengths and thicknesses
- Steel bodies & hardened steel shackle
- Supplied with differ cylinder as standard
- Nickel plated finish
- 2 keys supplied as standard

Item Ref:	Description	Shackle Size	Shackle Clearance	Finishes
28050.55.0.SD	CISA Open shackle padlock - Steel body 55mm	11mm	25mm	NP
28050.56.0.SD	CISA Open shackle padlock - Steel body 55mm	11mm	45mm	NP
28050.57.0.SD	CISA Open shackle padlock - Steel body 55mm	11mm	65mm	NP
28050.70.0.SD	CISA Open shackle padlock - Steel body 70mm	14mm	25mm	NP
28050.71.0.SD	CISA Open shackle padlock - Steel body 70mm	14mm	45mm	NP
28050.72.0.SD	CISA Open shackle padlock - Steel body 70mm	14mm	65mm	NP

CISA 28000 Series

Hardened Steel Slide Bolt



28550

General Description

Provide a high level of attack resistance and strict control of key duplication.

Principal Features

- Steel bodies and hardened steel slide bolt
- Range of shackle lengths & thicknesses
- Nickel plated finish
- 2 keys supplied as standard

Item Ref:	Description	Shackle Size	Shackle Clearance	Finishes
28550.66.0.SD	CISA Slide bolt shackle - Steel body 66mm	10mm	11mm	NP
28550.67.0.SD	CISA Slide bolt shackle - Steel body 66mm	14mm	17.5mm	NP
28550.75.0.SD	CISA Slide bolt shackle - Steel body 75mm	12mm	13.5mm	NP
28550.84.0.SD	CISA Slide bolt shackle - Steel body 84mm	12mm	17.5mm	NP
28550.85.0.SD	CISA Slide bolt shackle - Steel body 84mm	14mm	17.5mm	NP

CISA 22000 Series

Brass Body Padlocks



22011



22010



General Description

Provide a low to medium attack resistance and convenient key duplication.

Principal Features

- Range of shackle lengths & thicknesses
- Brass bodies and hardened steel shackle
- Nickel plated shackle finish as standard
- Satin brass finished body
- 2 keys supplied as standard

Item Ref:	Description	Shackle Size	Shackle Clearance	Finishes
22010.30.0 Differ	CISA standard shackle - Brass body 30mm - Standard differ	5mm	17mm	NP/PB
22010.40.0 Differ	CISA standard shackle - Brass body 40mm - Standard differ	6mm	23mm	NP/PB
22010.50.0 Differ	CISA standard shackle - Brass body 50mm - Standard differ	8mm	27.5mm	NP/PB
22010.60.0 Differ	CISA standard shackle - Brass body 60mm - Standard differ	10mm	37.5mm	NP/PB
22011.30.0 Differ	CISA long shackle - Brass body 30mm - Standard differ	5mm	24mm	NP/PB
22011.40.0 Differ	CISA long shackle - Brass body 40mm - Standard differ	6mm	40mm	NP/PB
22011.50.0 Differ	CISA long shackle - Brass body 50mm - Standard differ	8mm	80mm	NP/PB

CISA 21000 Series

'Logo Line' Padlocks

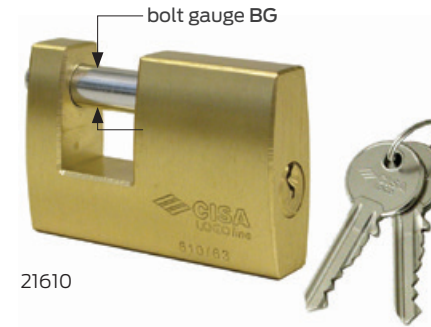

21610

Principal Features

- Slide bolt design
- Brass solid bodies with nickel plated hardened steel sleeve
- Nickel plated hardened steel shackle
- 2 keys supplied as standard

Item Ref:	Description	Shackle Size	Shackle Clearance	Finishes
21610.50.0.SD1	CISA Slide bolt shackle - Brass body 52mm - 15mm BG	7.94mm	13.5mm	NP/PB
21610.63.0.SD1	CISA Slide bolt shackle - Brass body 63mm - 19mm BG	10mm	14mm	NP/PB
21610.70.0.SD1	CISA Slide bolt shackle - Brass body 70mm - 22mm BG	12mm	13.5mm	NP/PB
21610.90.0.SD1	CISA Slide bolt shackle - Brass body 90mm - 35mm BG	12mm	18.2mm	NP/PB



Principal Features

- Slide bolt design
- Brass solid bodies with nickel plated hardened steel sleeve
- Nickel plated hardened steel shackle

Item Ref:	Description	Shackle Size	Shackle Clearance	Finishes
21810.65.0.SD1	CISA Slide bolt shackle - Brass body 66mm - 33mm BG	10mm	14mm	NP/PB
21810.80.0.SD1	CISA Slide bolt shackle - Brass body 77.1mm - 37mm BG	12mm	17mm	NP/PB

CISA 21000 Series

'Logo Line' Marine Grade Padlocks



- Performance Level 2
- Exceptional level of corrosion resistance
- Range of shackle lengths & thicknesses
- Chrome plated brass body
- Stainless steel shackle
- Double locking shackle
- Patented anti-tamper, anti-pick protection
- 2 keys as standard

Item Ref:	Description	Shackle Size	Shackle Clearance	Finishes
21710.30.0.SD	Logo Line Marine Grade padlock - 29mm body	4.75mm	13.8mm	SCP
21710.40.0.SD	Logo Line Marine Grade padlock - 40mm body	6.35mm	22.5mm	SCP
21710.50.0.SD	Logo Line Marine Grade padlock - 50mm body	7.14mm	26mm	SCP
21710.60.0.SD	Logo Line Marine Grade padlock - 60mm body	7.94mm	32.2mm	SCP

CISA 41000 Series

Roller Shutter Locks

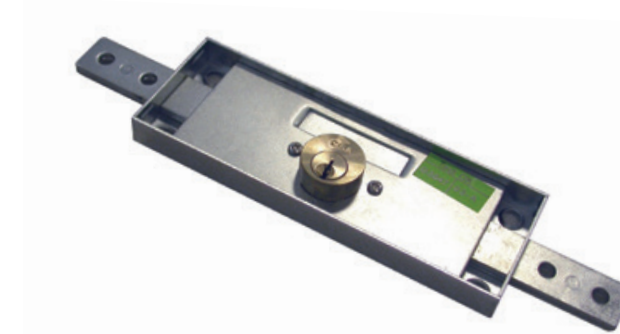

- Principal Features**
- Performance Level 1
  - Lock is operated by key from inside and outside
  - Zinc plated case
  - Supplied as standard differ
  - 2 keys as standard

Item Ref:	Description	Finishes
41510.78.0.SD	Roller shutter lock - Central application	NP/PB
41525.78.0.SD	Roller shutter lock - Pair for right hand/left hand application	NP/PB
41525.78.1.SD	Roller shutter lock - Right hand/left hand application	NP/PB
41525.78.2.SD	Roller shutter lock - Right hand/left hand application	NP/PB
41526.78.0.SD	Roller shutter lock - Pair for right hand/left hand application	NP/PB

Schlage Security

Vehicle Padlock & Hasp



- Principal Features**
- Designed for use in high risk areas
  - Hardened steel shackle resists prying and sawing attack
  - Designed for use with the vehicle hasp
  - Ideal for vehicle security

Item Ref:	Description	Dimensions
720018855156	Shackle-less padlock	73mm case
720018855101	Security hasps	264 x 216 x 216mm



**Briton Door Furniture**

The Briton door hardware ranges are compact ranges of door furniture which are ideally suited for use with the Briton 5600, 5500 and 5400 Lock Series.

Both ranges feature a selection of rose mounted lever furniture with matching escutcheons and a co-ordinated pull handle to satisfy the majority of door functions.

**Durability**

All items are manufactured in stainless steel for strength, durability and corrosion resistance.

All leversets are pre-fixed to roses and are assembled using bolt through fixings and a through spindle which is fixed to each lever by grub screws.

Briton contract levers have all been successfully tested to EN 1906 Grade 3.

Briton commercial levers have all been successfully tested to EN 1906 Grade 4 .

**The Equality Act (disability legislation)**

This legislation places a duty to avoid discrimination against disabled people and requires that reasonable adjustments are made to the design of buildings to provide a universal level of access.

In such circumstances the recommendations of BS 8300 and Approved Document M of the Building Regulations will be used as the basis for determining best practice.

In general terms, doors must be easy to use for the maximum number of users and a badly designed, positioned or fitted handle may form a barrier to some people.

Lever Furniture - recommendations in BS8300 include a 'hand grip' zone as indicated opposite (Fig.1). Fixing heights for lever furniture are recommended at 800 - 1050mm from floor level (with 900mm the preferred position).

Locks - are recommended to have a backset of at least 54mm and with the handle to cylinder position 72mm maximum.

Pull Handles - lengths and mounting positions are as indicated opposite (Fig.2). The minimum length of pull handle is 300mm. Handle diameters of 19 - 35mm are recommended.

It is also recommended to fit a horizontal pull handle to doors which are not fitted with self closing devices to assist wheelchair users in closing the door (Fig.3).

Thumbturns - should be avoided where possible as they can be difficult to operate for people with limited mobility or strength such as those with arthritis. Where they are needed they should be as large and easy to operate as possible.

Where products comply with these recommendations they are marked with the wheelchair symbol.

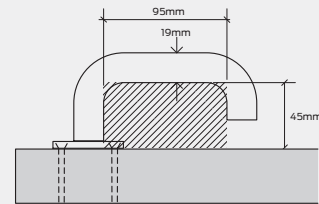

Fig.1

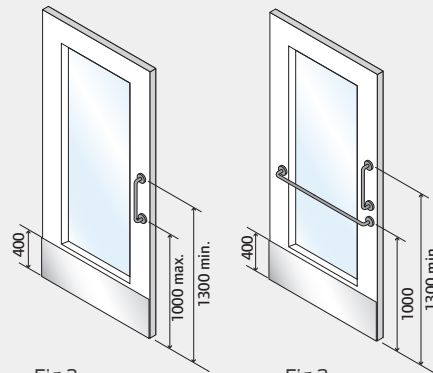

Fig.2

Fig.3

**Briton 4700 Series**

**Leversets**

**General Description**

The Briton 4700 Series of door hardware is a high quality, high specification range of lever and pull handle door furniture and accessories in satin stainless steel.

The range encompasses the complete hardware requirement of the large majority of doorsets.

**Principal Features**

- Stainless steel grade 304
- Back to back fixing bolts and threaded bushes on lever furniture
- Levers are prefixed to unsprung roses only 4mm thick
- Unique 'ClickFit' systems for rose and escutcheon covers
- Supplied with bolt through fixings and spindle suitable for doors 44 - 54mm thick
- Spindles fixing with "break thru" grub screws for greater security and durability

■ **Testing:**

EN 1906 - Grade 4 category of use  
EN 1670 - Grade 3 corrosion resistance  
EN Classification 4 7 - B 1 4 0 U

EN 1634 for up to 2 hour timber fire door applications and up to 4 hour steel fire door applications

- **Guarantee: 10 years**



**Finishes**

Available in satin stainless steel



Items which meet the recommendations of BS 8300 to provide easy access are marked with this icon.

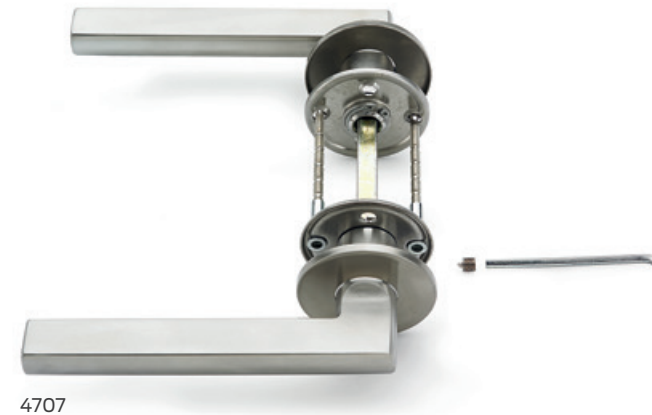

4707

Briton 4700 Series

Leversets



4701.20.140



4701.20.175



4701.22.140



4703.20.140



4704.20.140



4705.20.140



4706



4707



4708

Item Ref:	Description	Finish
4701.20.140	Lever handle on rose - Round bar return to door - 20mmØ x 140mm	SS
4701.20.175	Lever handle on rose - Round bar return to door - 20mmØ x 175mm	SS
4701.22.140	Lever handle on rose - Round bar return to door - 22mmØ x 140mm	SS
4703.20.140	Lever handle on rose - Round bar straight - 20mmØ x 140mm	SS
4704.20.140	Lever handle on rose - Round bar straight mitred - 20mmØ x 140mm	SS
4705.20.140	Lever handle on rose - Round bar curved mitred - 20mmØ x 140mm	SS
4706	Lever handle on rose - Wing design - 63mm x 130mm	SS
4707	Lever handle on rose - Hollow cut away flat lever - 56.5mm x 135mm	SS
4708	Lever handle on rose - Hollow curve form lever - 60mm x 122mm	SS
4701.55-65.FS	Fixing set for 55-65mm door thickness, including spindle & screw set	n/a

Briton 4700 Series

Escutcheons & Plates

General Description

A series of escutcheons with matching push on covers in stainless steel for use with Briton Contract leversets.



4713.4



4714.4



4715.4



4710



4711

Item Ref:	Description	Finish
4713.4	Escutcheons (pair) - Euro profile cylinder suitable for euro profile or dual profile cylinder lock cases	SS
4714.4	Escutcheons (pair) - Lever key suitable for lever lock cases	SS
4715.4	Escutcheons (pair) - Blank	SS
4710	Bathroom turn and indicator set (pair) - c/w 8mm bathroom function spindle	SS
4711	Bathroom extended turn and indicator set (pair) - c/w 8mm bathroom function spindle	SS

Briton 4700 Series

Plate mounted levers



Principal Features

- Levers mounted on square backplates
- All plates 170 x 170mm
- 22mm Ø return to door lever
- EN 1906 Grade 4
- Supplied as a pair c/w spindle and bolt through fixings to suit 44 - 54mm doors

Item Ref:	Description	Finish
4702BP.B.22.140	Plate mounted lever handles (Pair) - Blank for use with latches	SS
4702BP.EC.22.140	Plate mounted lever handles (Pair) - Cutout for euro profile cylinders (72ccs)	SS
4702BP.WC.22.140.L*	Plate mounted lever handles (Pair) - Bathroom function (78ccs) - Left hand	SS
4702BP.WC.22.140.R*	Plate mounted lever handles (Pair) - Bathroom function (78ccs) - Right hand	SS

\* Bathroom function plates are handed - Pair shown above are left hand.

Briton 4700 Series Pull Handles

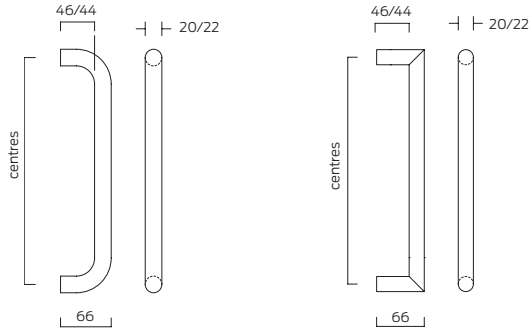

Principal Features

- Each pull handle is ordered individually. For back to back assemblies simply order two individual pull handles
- Order a universal fixing pack for each pull handle ordered
- Universal fixing pack for bolt through and back to back assembly on solid or glass doors
- Optional rose fixing. One pack required for each pull handle

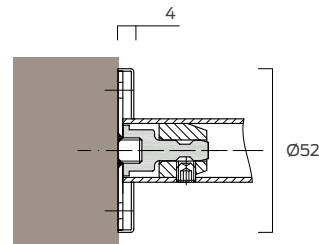

Rose mount fixings

Briton 4721 and 4722 pull handles can be ordered with an optional face fixed rose. Roses are supplied with stainless steel face fixing screws. Snap fit push on covers conceal all fixings.

Briton 4700 Series Pull Handles

Universal fixing pack options

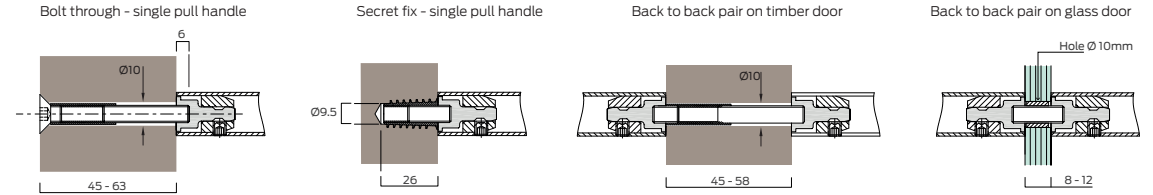

Item Ref:	Description	Finish
4721.20.200	'D' Pull handle - 20mmØ - 200mm centres	SS
4721.22.200	'D' Pull handle - 22mmØ - 200mm centres	SS
4721.20.300	'D' Pull handle - 20mmØ - 300mm centres	SS
4721.22.300	'D' Pull handle - 22mmØ - 300mm centres	SS
4721.20.400	'D' Pull handle - 20mmØ - 400mm centres	SS
4721.22.400	'D' Pull handle - 22mmØ - 400mm centres	SS
4721.20.600	'D' Pull handle - 20mmØ - 600mm centres	SS
4721.22.600	'D' Pull handle - 22mmØ - 600mm centres	SS
4722.20.200	Pull handle - mitred - 20mmØ - 200mm centres	SS
4722.22.200	Pull handle - mitred - 22mmØ - 200mm centres	SS
4722.20.300	Pull handle - mitred - 20mmØ - 300mm centres	SS
4722.22.300	Pull handle - mitred - 22mmØ - 300mm centres	SS
4722.20.400	Pull handle - mitred - 20mmØ - 400mm centres	SS
4722.22.400	Pull handle - mitred - 22mmØ - 400mm centres	SS
4722.20.600	Pull handle - mitred - 20mmØ - 600mm centres	SS
4722.22.600	Pull handle - mitred - 22mmØ - 600mm centres	SS
4726	Standard fixing pack for bolt through, secret fix or back to back fixing	
4725.20	Face fixed rose mounting kit for 20mmØ pull handles	
4725.22	Face fixed rose mounting kit for 22mmØ pull handles	

Briton 4700 Series

Pull Handles

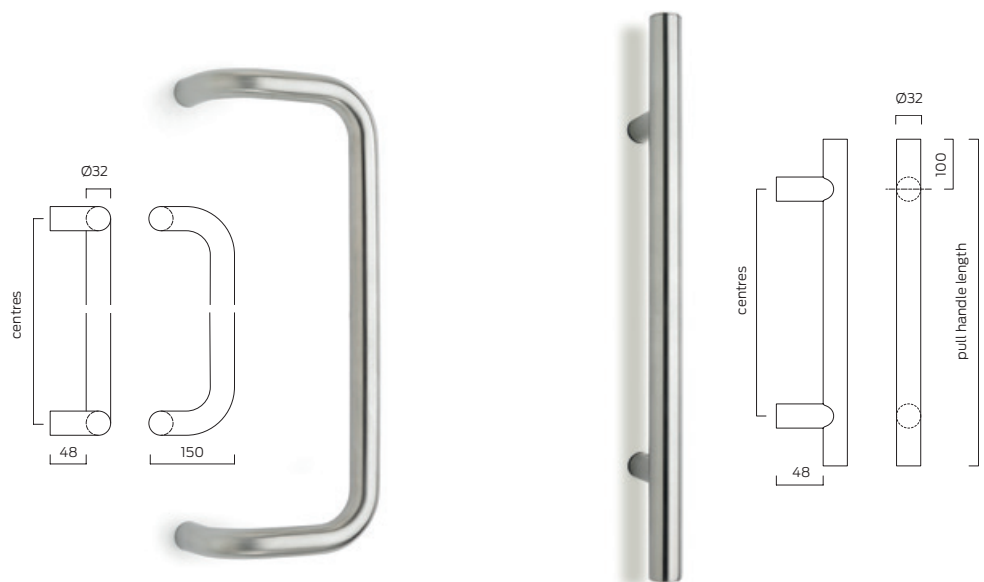

Item Ref:	Description	Finish
4723.32.400	Cranked pull handle - round bar section - 32mmØ - 400mm centres	SS
4723.32.600	Cranked pull handle - round bar section - 32mmØ - 600mm centres	SS
4724.32.400	Pillar fixed pull handle - round bar section - 32mmØ - 400mm centres	SS
4724.32.600	Pillar fixed pull handle - round bar section - 32mmØ - 600mm centres	SS
4726	Standard fixing pack for bolt through, secret fix or back to back fixing	

Briton 4700 Series

Plates & Cylinder Pulls

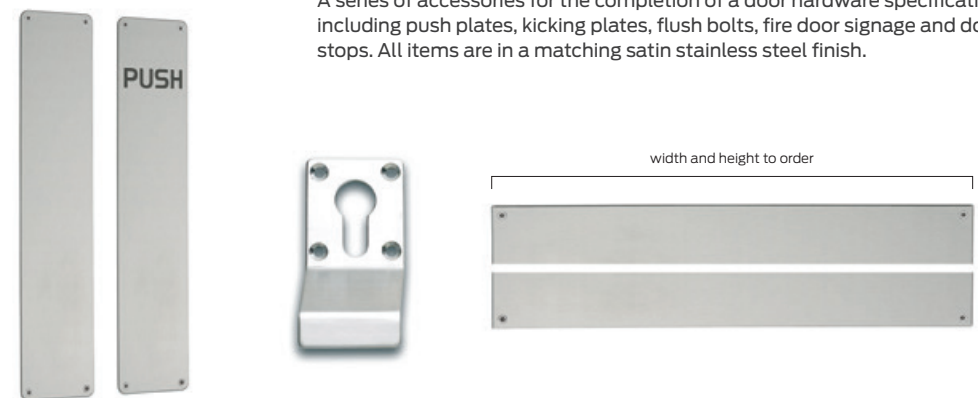

General Description

A series of accessories for the completion of a door hardware specification, including push plates, kicking plates, flush bolts, fire door signage and door stops. All items are in a matching satin stainless steel finish.

Item Ref:	Description	Finish
4730.75.375	Push plate with radiused corners - 75 x 375mm - Plain	SS
4730.75.475	Push plate with radiused corners - 75 x 475mm - Plain	SS
4730.75.675	Push plate with radiused corners - 75 x 675mm - Plain	SS
4731.75.375	Push plate with radiused corners - 75 x 375mm - Engraved "PUSH"	SS
4731.75.475	Push plate with radiused corners - 75 x 475mm - Engraved "PUSH"	SS
4731.75.675	Push plate with radiused corners - 75 x 675mm - Engraved "PUSH"	SS
4732.75.375	Push plate with radiused corners - 75 x 375mm - Engraved "PULL"	SS
4732.75.475	Push plate with radiused corners - 75 x 475mm - Engraved "PULL"	SS
4732.75.675	Push plate with radiused corners - 75 x 675mm - Engraved "PULL"	SS
4733	Cylinder pull 91.5 x 43mm - Aperture for euro profile cylinder	SS
4760.304	Kick plate 1.2mm thick* - Square corners with face fixing screws - Grade 304	SS
4761.304	Kick plate 1.5mm thick* - Square corners with face fixing screws - Grade 304	SS

\* height and width of kick plates are to order

Briton 4700 Series

Signs & Symbols

General Description

A range of 76mm dia. stainless steel face fixed signs and symbols.



Item Ref:	Description	Finish
4750.01	Unisex symbol	SS
4750.02	Male symbol	SS
4750.03	Female symbol	SS
4750.04	Disabled symbol	SS
4750.05	WC sign	SS
4750.06	Shower symbol	SS

Item Ref:	Description	Finish
4750.07	Baby change symbol	SS
4750.08	Push	SS
4750.09	Pull	SS
4750.10	Fire door keep shut	SS
4750.11	Fire door keep locked	SS
4750.12	Automatic fire door keep clear	SS

Briton 4700 Series

Entrance Door Accessories



Item Ref:	Description	Finish
482	Security door guard in cast steel	-
U696	Door viewer - small - for door thicknesses 35 - 52mm - max. viewing angle 150°	-
U698	Door viewer - large - for door thicknesses 35 - 54mm - max. viewing angle 180°	-

Briton 4700 Series

Flush Bolts

General Description

A series of flush bolts used to secure the inactive leaf of an equal or unequal pair of doors.

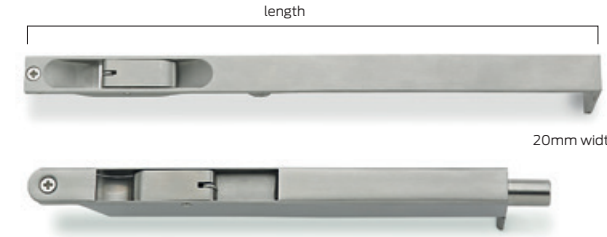

Item Ref:	Description	Finish
4735.R.20.202	Flush bolt - radiused end - 20mm x 202mm	SS
4735.R.20.300	Flush bolt - radiused end - 20mm x 300mm	SS
4735.R.20.450	Flush bolt - radiused end - 20mm x 450mm	SS
4735.R.20.600	Flush bolt - radiused end - 20mm x 600mm	SS
4735.R.20.914	Flush bolt - radiused end - 20mm x 914mm	SS
4735.S.20.202	Flush bolt - square end - 20mm x 202mm	SS
4735.S.20.300	Flush bolt - square end - 20mm x 300mm	SS
4735.S.20.450	Flush bolt - square end - 20mm x 450mm	SS
4735.S.20.600	Flush bolt - square end - 20mm x 600mm	SS
4735.S.20.914	Flush bolt - square end - 20mm x 914mm	SS
4739.R.18.225	Fully enclosed flush bolt - radiused end - 18mm x 225mm	SS
4739.S.18.225	Fully enclosed flush bolt - square end - 18mm x 225mm	SS

Principal Features

- Lever action flush bolts
- Radiused or square end versions
- Available in various lengths
- Open type body or fully enclosed

■ Testing: EN 12051:1999

Finishes

Available in satin stainless steel



Item Ref:	Description	Finish
FB41P	Automatic flush bolts activated by the opening/closing action of the door (pair)	-



Item Ref:	Description	Finish
4736	Plunger type dust excluding floor socket	-
4737	Easy clean floor socket - face fixing	-

Briton 4700 Series Door Stops



Item Ref:	Description	Finish
4740	Domed floor door stop - 45mmØ x 24mm - supplied with stainless steel fixings	SS
4741	Floor mounted door stop - 40mmØ x 38mm - supplied with stainless steel fixings	SS
4742	Wedge shaped floor door stop - 46mmØ x 26mm - supplied with stainless steel fixings	SS
4743	Wall or skirting mounted door stop - 50mmØ x 90mm - supplied with stainless steel fixings	SS

Briton 4700 Series Hooks



Item Ref:	Description	Finish
4744	Single hook - small face fixed - 32mmØ x 46mm	SS
4745.1	Single hook - large face fixed - 48mmØ x 100mm	SS
4745.2	Double hook - large face fixed - 48mmØ x 100mm x 70mm	SS

Briton 4800 Series Hinges



Principal Features

- BS EN 1935 Grade 13
  - Suitable for timber and metal doors up to 120 kgs
  - 5 knuckle ball bearing hinges
  - Template drilled
- 
- Testing:  
BS EN 1935 Grade 13  
Fire tested to EN 1634 on timber doors to achieve 30min and 60min fire rating  
Fire tested to EN 1634 on metal doors to 30, 60, 120 & 240min fire rating
  - Guarantee: 10 years



Item Ref:	Description	CE Classification	Finish
4801	Hinge - 102 x 76 x 3mm - Stainless steel grade 304	4 7 6 1 1 4 0 13	SS; PS
4802	Hinge - 102 x 89 x 3mm - Stainless steel grade 304	4 7 6 1 1 4 0 13	SS; PS
4803	Hinge - 102 x 102 x 3mm - Stainless steel grade 304	4 7 6 1 1 4 0 13	SS; PS
4801.316	Hinge - 102 x 76 x 3mm - Stainless steel grade 316	4 7 6 1 1 4 0 13	SS; PS
4802.316	Hinge - 102 x 89 x 3mm - Stainless steel grade 316	4 7 6 1 1 4 0 13	SS; PS
4803.316	Hinge - 102 x 102 x 3mm - Stainless steel grade 316	4 7 6 1 1 4 0 13	SS; PS

Briton 4200 Series Contract Leversets

General Description

The Briton 4200 Series of door hardware is a cost effective range of lever furniture and accessories in the most popular designs. All items are available in a satin stainless steel finish.



Principal Features

- Stainless steel grade 304
- Prefixed to 8mm thick sprung roses
- All levers 19mmØ
- Supplied with M4 bolt through fixings and spindle suitable for doors 38 - 54mm thick

- Testing:
  - EN 1906 - Grade 3 Category of Use
  - EN1906 - Grade 7 Durability (200,000 cycles)
  - EN 1670 - Grade 3 Corrosion Resistance
  - EN Classification 3 7 - B13 0 B
  - EN 1634 for up to 2 hour timber fire door applications and up to 4 hour steel fire door applications

- Guarantee: 5 years



Finishes

Available in satin stainless steel only



Item Ref:	Description	Finish
4201.19.SS	Lever handle on rose - round bar return to door - 19mm x 135mm	SS
4203.19.SS	Lever handle on rose - round bar straight - 19mm x 135mm	SS
4204.19.SS	Lever handle on rose - round bar straight mitred - 19mm x 135m	SS
4205.19.SS	Lever handle on rose - round bar curved mitred - 19mm x 135mm	SS

Briton 4200 Series Escutcheons

General Description

A series of escutcheons with matching push on covers in stainless steel for use with Briton 4200 Series leversets.



Item Ref:	Description	Finish
4213.8.SS	Escutcheons (pair) - Euro profile cylinder suitable for euro profile or dual profile cylinder locks	SS
4214.8.SS	Escutcheons (pair) - Lever key suitable for lever locks	SS
4215.8.SS	Escutcheons (pair) - Blank	SS
4210	Bathroom turn & indicator set (pair) - c/w 8mm bathroom function spindle	SS
4211	Bathroom extended turn & indicator set (pair) - c/w 8mm bathroom function spindle	SS
4200.5.FP	Fixing pack - c/w 5mm spindle and adaptor for lockcases with 8mm bathroom function followers.	n/a

**Normbau Design System**

Normbau is a comprehensive range of colour co-ordinated architectural hardware offering durable, long lasting door furniture and specially designed fittings for elderly and disabled users.

The versatile range of levers and pull handles in a selection of sizes and fixing options are available as either solid nylon or with a corrosion resistant steel core for extra strength.

**Special Needs Programme**

The Normbau range features a large selection of products including cloakroom fittings, shower rails and support systems designed specifically for the elderly and people with special needs. The range will provide many solutions to washroom and bathing facilities to meet the demands of The Equality Act.

Nylon incorporates a unique textured surface to provide improved grip and being a poor conductor of heat is comfortable to touch compared to similar products in stainless steel.

The high impact colours are also particularly suitable for areas used by partially sighted people as they provide the opportunity to maximise contrast with the surrounding surfaces.

Normbau support systems are fully modular and are designed to meet the standard requirement of Part M of the Building Regulations.



**Suitability of Nylon**

Normbau architectural hardware is in constant use in public and commercial buildings throughout the world and has a proven track record of durability and performance.

As the nylon is coloured throughout, the colour will not chip or scratch off, it will not fade or wear off with rough handling and this makes it an ideal choice for use in areas of heavy usage.

**Fire Testing**

Door furniture has been successfully tested to EN 1634 for use on timber fire doors with up to 2 hour fire rating and up to 4 hour on steel doors. Please contact us for further information.

**Standards**

Normbau products have been approved by the PSA for MOB H3PS high duty performance standards and lever sets conform to EN 1906.



**Infection control**

Normbau antibacterial protection is an integral constituent embedded within the nylon during production which provides effective and long-lasting protection against the growth of harmful micro-organisms and bacteria such as E.coli, S. aureus and MRSA.

It provides an extra level of hygiene in hospitals, care homes and many other types of public access buildings, helping to keep surfaces cleaner and reduce the risk of cross-contamination.

Please note, colours marked † below have the Normbau antibacterial protection as standard.

All products are available as standard in 9 distinctive colours. Other colours to match corporate environments can be achieved at additional cost.

For the purpose of colour co-ordination with other building elements we have provided the nearest RAL-DS colour reference.

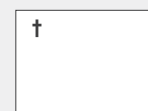

White 19 - NWH  
RAL-DS 000 95 00

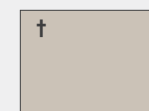

Manhattan 67 - NMG  
RAL-DS 080 70 05



Dk Grey 18 - NDG  
RAL-DS 000 35 00



Black 16 - NBL  
RAL-DS 000 15 00



Slate Blue 63 - NSB  
RAL-DS 240 50 15

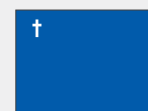

Blue 11 - NBU  
RAL-DS 270 30 40



Dk Blue 37 - NDB  
RAL-DS 270 20 25



Red 12 - NRE  
RAL-DS 030 30 45



Yellow 22 - NYE  
RAL-DS 080 80 90

† Colours with antibacterial protection as standard



Normbau

Door Furniture

Normbau

Leversets

**General Description**

A comprehensive range of colour co-ordinated architectural hardware offering durable door furniture and accessories.



0282 01 coupe lever with 0525 10 latch backplate

**Principal Features**

- Solid nylon material with colour running all the way through which cannot be scratched or chipped off
- Lever furniture is available either pre-assembled with rose or backplate, or separate to a range of roses or backplates for added flexibility
- Lever handles are available in solid nylon or with a steel core for added strength
- Lever and rose assemblies are available with simple nylon bearing or with a quick assembly, maintenance free ball bearing race
- Pull handles of 300mm centres and above comply with the recommendations of BS8300

■ **Testing:**

EN 1906 - Grade 4 category of use  
 Fire tested to EN1634 on timber doors to achieve 1 hour fire rating (pull handles)  
 2 hour rating (lever furniture) and 4 hour for metal doors (pull and lever furniture)

Approved by PSA to MOB H3PS high duty performance

- Guarantee: 5 years
- Full Declaration of Performance available from our website at:
- [www.britondops.co.uk](http://www.britondops.co.uk)



**Lever assemblies**

Levers are supplied in 3 arrangements with loose roses or backplates (as shown opposite) or pre-assembled with the rose or backplate inner.

In all cases, one lever is supplied with a floating spindle which engages within the lever on the opposite side.

All lever and rose or backplate assemblies are supplied with back to back though fixings to give a positive and durable assembly.



Ball Bearing rose assembly

Pre-assembled lever and rose

Spindle fixed levers and rose

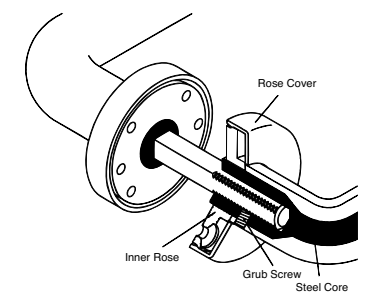
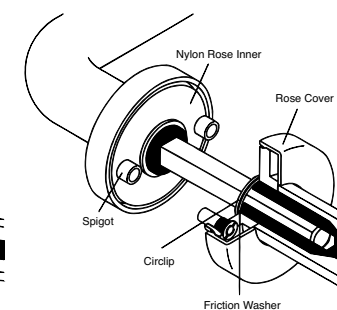
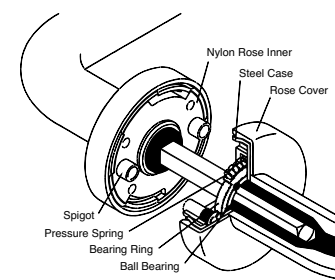

Normbau

Ball Bearing Mounted Levers



0282 01

General Description

A comprehensive range of lever handles for mounting on separate roses or backplates with a ball bearing assembly.

Principal Features

- Levers are steel cored for added strength
- Designed for use with roses and backplates with ball bearing assemblies
- Choose lever type and rose or backplate separately
- Lever and rose/backplate colour can be the same or different
- Available as a pair c/w spindle or half pair with or without spindle

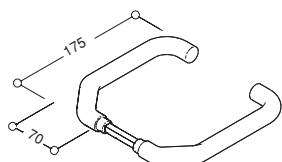

Item Ref:	Description
0388 01	Cranked lever handle pair- 23mm dia. - c/w spindle
0388 03	Cranked lever handle half pair - 23mm dia. - without spindle
0388 41	Cranked lever handle half pair - 23mm dia. - c/w half spindle

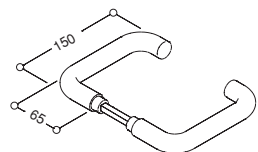

Item Ref:	Description
0389 01	Lever handle pair- 23mm dia. - c/w spindle
0389 03	Lever handle half pair - 23mm dia. - without spindle
0389 41	Lever handle half pair - 23mm dia. - c/w half spindle

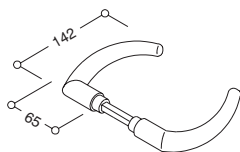

Item Ref:	Description
0282 01	Coupe lever handle pair- 23mm dia. - c/w spindle
0282 03	Coupe lever handle half pair - 23mm dia. - without spindle

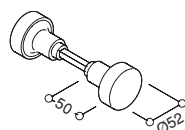

Item Ref:	Description
0387 01	Knob pair- 52mm dia. - c/w spindle
0387 05	Knob pair half pair - 52mm dia. - without spindle

Normbau

Ball Bearing Mounted Levers



0389 01 lever with 0405 02 backplate for euro profile cylinder



0397 40



0282 01 lever with 0390 03 bearing rose

Principal Features

- Rose and backplate options with ball bearing mounting
- Roses and backplates supplied with bolt through fixings to suit door thicknesses shown - other sizes also available
- Escutcheons supplied with wood screw face fixings
- All escutcheons and backplates are sold as pairs

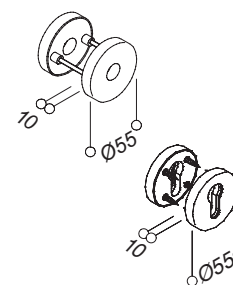

Item Ref:	Description
0390 03	Rose - 55mm dia. ball bearing rose
0396 26	Escutcheon 55mm dia. - blind for use with latches.
0396 29	Escutcheon 55mm dia. - for lever key locks
0396 30	Escutcheon 55mm dia - for euro profile cylinder
0397 40	Escutcheon with bathroom turn & indicator - 55mm dia.

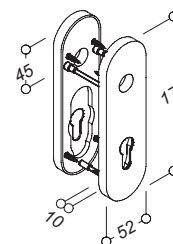

Item Ref:	Description
0405 05	Ball bearing backplate for latches
0405 02	Ball bearing backplate for euro profile cylinder locks - 72mm centres
0405 03**	Ball bearing backplate for bathroom locks - 78mm centres
** supplied with 8mm spindle	

Normbau

Spindle Fixed Levers

**General Description**

A comprehensive range of lever handles for mounting on separate nylon roses or backplates.

**Principal Features**

- Choose lever type and rose or backplate separately
- Levers are available in solid nylon or steel cored
- Lever and rose/backplate colour can be the same or different
- Supplied as a pair with spindle - half sets with half spindle also available
- Roses and backplates supplied with bolt through fixings to suit door thicknesses 38 - 52mm - other sizes also available
- Escutcheons supplied with face fixings



0571 08 lever on 0525 09 backplate

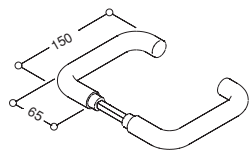
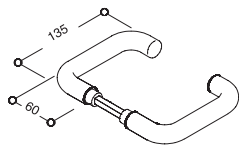

Item Ref:	Description
0246 08	Lever handle pair solid nylon- 20mm dia.
0570 15	Lever handle pair steel cored - 20mm dia. (for doors 23 - 37mm)
0570 08	Lever handle pair steel cored - 20mm dia. (for doors 38 - 52mm)
0570 14	Lever handle pair steel cored - 20mm dia. (for doors 53 - 63mm)

Item Ref:	Description
0246 18	Lever handle pair solid nylon- 23mm dia.
0571 15	Lever handle pair steel cored - 23mm dia. (for doors 23 - 37mm)
0571 08	Lever handle pair steel cored - 23mm dia. (for doors 38 - 52mm)
0571 14	Lever handle pair steel cored - 23mm dia. (for doors 53 - 63mm)

Normbau

Spindle Fixed Levers

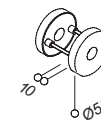
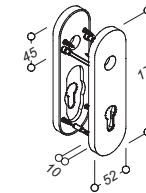
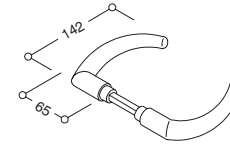

Item Ref:	Description
0577 01	Coupe lever handle pair steel cored - 23mm dia. (for doors 23 - 37mm)
0577 02	Coupe lever handle pair steel cored - 23mm dia. (for doors 38 - 52mm)
0577 03	Coupe lever handle pair steel cored - 23mm dia. (for doors 53 - 63mm)

Item Ref:	Description
0525 10	Backplate pair for latch only
0525 08	Backplate pair for lever key - 57mm centres
0525 09	Backplate pair for euro profile cylinder 57mm centres
0523 22	Backplate pair for euro profile cylinder 72mm centres
0525 13	Backplate pair for oval cylinder 48.5mm centres
0525 14	Backplate pair for oval cylinder 56mm centres
0525 12	Backplate pair for oval cylinder 57mm centres
0525 11	Backplate pair for bathroom function - 57mm centres (5mm spindle)
0524 28	Backplate pair for bathroom function - 78mm centres (8mm spindle)

Item Ref:	Description
0247 26	Escutcheon pair - 52mmØ - blind
0247 31	Escutcheon pair - 52mmØ - lever key
0247 32	Escutcheon pair - 52mmØ - euro profile cylinder
0247 90	Escutcheon pair - 52mmØ - oval cylinder
0358 34	Escutcheon pair - 52mmØ - bathroom function (5mm spindle)
6432 00	Escutcheon pair - 52mmØ - bathroom function (8mm spindle)
0396 26	Escutcheon pair - 55mmØ - blind
0396 29	Escutcheon pair - 55mmØ - lever key
0396 30	Escutcheon pair - 55mmØ - euro profile cylinder
0396 47	Escutcheon pair - 55mmØ - oval cylinder
0397 40	Escutcheon pair - 55mmØ - bathroom function (8mm spindle)

Normbau

Circlip Fixed Levers



**General Description**

A comprehensive range of lever handles pre-fixed to nylon roses or backplates.

**Principal Features**

- Levers are circlip mounted to the rose or backplate inner for added strength
- Available with 52mm or 55mm diameter roses and matching escutcheons
- Push on covers conceal rose fixings
- Supplied as a pair with spindle - half sets with half spindle also available
- Roses and backplates supplied with bolt through fixings to suit door thicknesses shown - other sizes also available
- Escutcheons supplied with face fixings

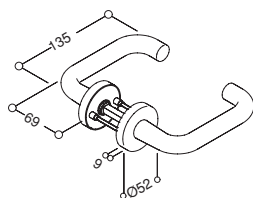

Item Ref:	Description
0516 01	Lever handle pair steel cored- 20mm dia. c/w 52mm dia roses

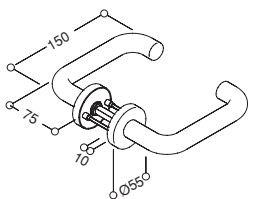

Item Ref:	Description
0516 03	Lever handle pair steel cored- 23mm dia. c/w 55mm dia roses

Normbau

Circlip Fixed Levers

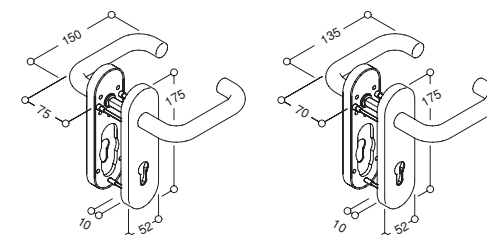

Description	20mm dia lever	23mm dia lever
Backplate pair for latch only	0623 20	0434 20
Backplate pair for lever key - 57mm centres	0623 73	0434 73
Backplate pair for euro profile cylinder 57mm centres	0623 74	0434 74
Backplate pair for euro profile cylinder 72mm centres	0623 17	0434 17
Backplate pair for oval cylinder 57mm centres	0623 75	0434 75
Backplate pair for oval cylinder 72mm centres	0623 76	0434 76
Backplate pair for bathroom function - 57mm centres (5mm spindle)	0623 77	0434 77
Backplate pair for bathroom function - 78mm centres (8mm spindle)	0623 18	0434 18



Description	52mm Ø	55mm Ø
Escutcheon pair - blind	0247 26	0396 26
Escutcheon pair - lever key	0247 31	0396 31
Escutcheon pair - euro profile cylinder	0247 32	0396 32
Escutcheon pair - oval profile cylinder	0247 90	0396 47
Escutcheon pair - bathroom function (5mm spindle)	0358 34	0397 40
Escutcheon pair - bathroom function (8mm spindle)	6432 00	-

Normbau

Pull Handles

General Description

A comprehensive range of pull handles in solid nylon or with steel cores for added strength.

Principal Features

- Large range of handle diameters and centres
- Available single sided for bolt through or face fixing
- For double sided back to back assemblies order a 'Thread Side' and a 'Pin Side' pull handle
- Fixing packs must be ordered separately as required - see page 140



0444 01

Description	Centres (mm)	Thread side pull	Pin side pull
Single bolt through pull - solid nylon	160	0309 17	n/a
Back to back pull handle pair - solid nylon	160	0309 19 (supplied as a pair without fixings)	
Single face fixed pull on 55mm dia rose - solid nylon	160	0309 20 (supplied with rose mounting)	
Pull handle steel cored	200	0439 01	0439 11
Pull handle steel cored	300	0444 01	0444 06
Pull handle steel cored	400	0363 19	0363 29
Pull handle steel cored	500	0363 18	0363 28
Pull handle steel cored	600	0363 17	0363 27
Pull handle - solid nylon	220	0363 01	0363 11
Pull handle - solid nylon	269	0364 01	0364 11

Normbau

Pull Handles - Made to Order

General Description

A range of steel cored pull handles made to order to fixing centres as required.

Principal Features

- Pull handles made to order
- Available as single bolt through or back to back assemblies
- For double sided back to back assemblies order a 'Thread Side' and a 'Pin Side' pull handle
- Fixing packs must be ordered separately as required - see page 140

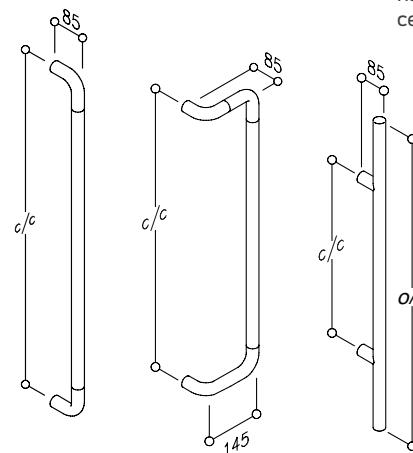

For pillar fixed pull handles 0767 21 to 0767 30 the overall length of the handles is C/C + 200mm.

Description	Centres (mm)	Thread side pull	Pin side pull
'D' Pull handle steel cored - 34mm dia.	230 - 670	0767 01	0767 06
'D' Pull handle steel cored - 34mm dia.	671 - 1170	0767 03	0767 08
'D' Pull handle steel cored - 34mm dia.	1171 - 1660	0767 04	0767 09
'D' Pull handle steel cored - 34mm dia.	1661 - 2200	0767 05	0767 10

Description	Centres (mm)	Thread side pull	Pin side pull
'Cranked' Pull handle steel cored - 34mm dia.	201 - 670	0767 11	0767 16
'Cranked' Pull handle steel cored - 34mm dia.	671 - 1170	0767 13	0767 18
'Cranked' Pull handle steel cored - 34mm dia.	1171 - 1600	0767 14	0767 19
'Cranked' Pull handle steel cored - 34mm dia.	1601 - 2200	0767 15	0767 20

Description	Centres (mm)	Thread side pull	Pin side pull
'Pillar Fixed' Pull handle steel cored - 34mm dia.	200 - 510	0767 21	0767 26
'Pillar Fixed' Pull handle steel cored - 34mm dia.	511 - 1010	0767 23	0767 28
'Pillar Fixed' Pull handle steel cored - 34mm dia.	1011 - 1460	0767 24	0767 29
'Pillar Fixed' Pull handle steel cored - 34mm dia.	1461 - 2200	0767 25	0767 30

**Normbau Pull Handles**

**General Description**

A comprehensive range of cranked pull handles in solid nylon.

**Principal Features**

- Available single sided for bolt through or face fixing
- For double sided back to back assembly order a 'Thread Side' and a 'Pin Side' pull handle
- Fixing packs must be ordered separately as required - see page 140

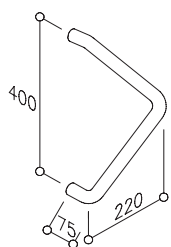

Description	Centres (mm)	Thread side pull	Pin side pull
'Cranked' Pull handle solid nylon - 34mm dia.	200	0440 09	0440 39
'Cranked' Pull handle solid nylon - 34mm dia.	300	0440 11	0440 41
'Cranked' Pull handle solid nylon - 34mm dia.	400	0440 13	0440 43

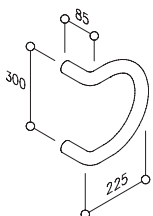

Description	Centres (mm)	Thread side pull	Pin side pull
'Cranked' Pull handle solid nylon - 34mm dia.	200	0440 01	0440 31
'Cranked' Pull handle solid nylon - 34mm dia.	300	0440 06	0440 36

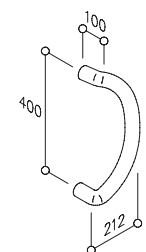

Description	Centres (mm)	Thread side pull	Pin side pull
'Cranked' Pull handle solid nylon - 34mm dia.	400	0440 10	0440 40

**Normbau Pull Handles**

**General Description**

A comprehensive range of cranked and straight pull handles.

**Principal Features**

- Available single sided for bolt through or face fixing
- For double sided back to back assembly order a 'Thread Side' and a 'Pin Side' pull handle
- Fixing packs must be ordered separately as required - see page 140

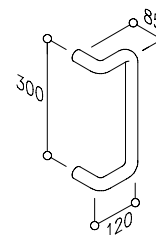

Description	Centres (mm)	Thread side pull	Pin side pull
'Cranked' Pull handle solid nylon - 31mm dia.	300	0443 12	0443 22
'Cranked' Pull handle solid nylon - 34mm dia.	200	0438 02	0438 12
'Cranked' Pull handle solid nylon - 34mm dia.	269	0303 06	0303 16
'Cranked' Pull handle solid nylon - 34mm dia.	300	0443 02	0443 32

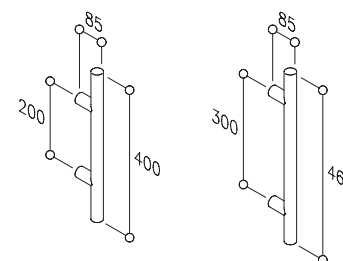

Description	Centres (mm)	Thread side pull	Pin side pull
'Pillar Fixed' Pull handle solid nylon - 34mm dia.	200	0441 01	0441 11
'Pillar Fixed' Pull handle solid nylon - 34mm dia.	300	0445 01	0445 11

Normbau Pull Handle Fixings

General Description

Each of the Normbau pull handles can be fixed using the fixing types shown below. Remember to match up the pull handle type (thread side or pin side) to the fixing application.

Description	Item Ref:	Application	
	0365 12	For 31mm dia. pull handles	
Bolt through fixing with cap screw cover (for use with thread side pulls)	0365 12	For 34mm dia. pull handles	
	0365 22	For 40mm dia. pull handles	
	0365 37	Bolt only	
Rose mounted with bolt through fixing and cap (for use with thread side pulls)	0381 17	For 31mm dia. pull handles - rose 70Ø	
	0365 17	For 34mm dia. pull handles - rose 70Ø	
	0365 27	For 40mm dia. pull handles - rose 80Ø	
Back to back fixing on timber doors suitable for all pull handles 31 to 40mm diameter (thread side & pin side pulls)	0471 11	For doors 38 - 48mm thick	
	0471 12	For doors 48 - 58mm thick	
Back to back fixing on glass doors suitable for all pull handles 31 to 40mm diameter (thread side & pin side pulls)	0471 44	For glass doors 8 - 18mm thick (hole dia. 12mm)	
Rose mounted and face fixed (for use with thread side pulls)	0381 19	For 31mm dia. pull handles - rose 70Ø	
	0365 19	For 34mm dia. pull handles - rose 70Ø	
	0365 29	For 40mm dia. pull handles - rose 80Ø	
Blind fixed on timber (for use with pin side pulls)	0471 32	All handle diameters 31 - 40mm	

Normbau

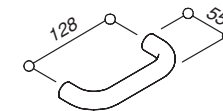
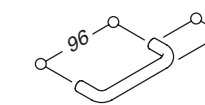
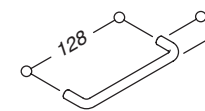
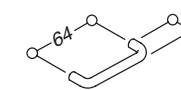

Cabinet Handles

Item Ref:	Description
0308 11	Cabinet pull - 9mmØ x 32mm - supplied without screws
0308 01	Cabinet pull - 11mmØ x 64mm - supplied without screws
0308 02	Cabinet pull - 11mmØ x 64mm - supplied with 4mm screws

Item Ref:	Description
0307 01	Cabinet pull - 10mmØ x 64mm - supplied without screws
0307 02	Cabinet pull - 10mmØ x 64mm - supplied with 4mm screws
0395 11	Cabinet pull - 10mmØ x 76mm - supplied without screws

Item Ref:	Description
0395 02	Cabinet pull - 10mmØ x 128mm - supplied without screws
0395 05	Cabinet pull - 10mmØ x 128mm - supplied with 4mm screws
0503 01	Cabinet pull - 10mmØ x 96mm - supplied without screws

Item Ref:	Description
0307 21	Cabinet pull - 12mmØ x 96mm - supplied without screws
0307 22	Cabinet pull - 12mmØ x 96mm - supplied with 4mm screws

Item Ref:	Description
0309 01	Cabinet pull - 20mmØ x 128mm - supplied without screws
0309 09	Cabinet pull - 20mmØ x 128mm - supplied with 4mm screws

Item Ref:	Description
0344 01	Cabinet knob - 32mmØ x 30mm
0391 01	Cabinet knob - 40mmØ x 40mm
0393 01	Cabinet knob - 40mmØ x 25mm
0234 02	Cabinet knob - 52mmØ x 52mm - pair
0234 04	Cabinet knob - 52mmØ x 52mm - single

Normbau

Flush Pulls & Doorstops

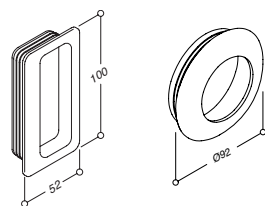

Item Ref:	Description
0342 01	Rectangular flush pull 100 x 52mm
0343 01	Circular flush pull 92mmØ
0343 02	Circular flush pull 78mmØ
0343 03	Circular flush pull 63mmØ

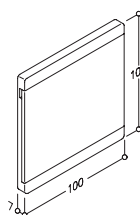

Item Ref:	Description
0846 01	Card frame with clear insert

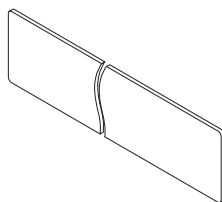

Item Ref:	Description
7000 42	Kicking plate available in size to order

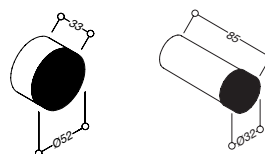

Item Ref:	Description
0345 01	Wall mounted door stop with soft buffer - 52mmØ x 33mm
0843 01	Wall mounted door stop with soft buffer - 32mmØ x 22mm
0355 01	Wall mounted door stop - 32mmØ x 20mm



Item Ref:	Description
0842 01	Floor mounted door stop with soft buffer - 52mmØ x 40mm
0842 03	Floor mounted door stop with soft buffer - 40mmØ x 38mm
0346 01	Floor mounted door stop with soft buffer - 52mmØ x 40mm

0346 01

0842 01

Briton 4700 Series



Signage

Item Ref:	Description
0510 01	Symbol - male - self adhesive 130mm high
0510 02	Symbol - female - self adhesive 130mm high
0510 04	Symbol - disabled - self adhesive 130mm high

Item Ref:	Description
0611 01	Figure 1 - 180mm high self adhesive
0611 02	Figure 2 - 180mm high self adhesive
0611 03	Figure 3 - 180mm high self adhesive
0611 04	Figure 4 - 180mm high self adhesive
0611 05	Figure 5 - 180mm high self adhesive
0611 06	Figure 6 & 9 - 180mm high self adhesive
0611 07	Figure 7 - 180mm high self adhesive
0611 08	Figure 8 - 180mm high self adhesive
0611 00	Figure 0 - 180mm high self adhesive
0611 09	Figure a - 123mm high self adhesive
0611 10	Figure b - 174mm high self adhesive
0611 11	Figure c - 123mm high self adhesive
0611 12	Figure d - 174mm high self adhesive
0611 19	Dash (-) - 27mm high self adhesive



Normbau

Letterplates & Hooks

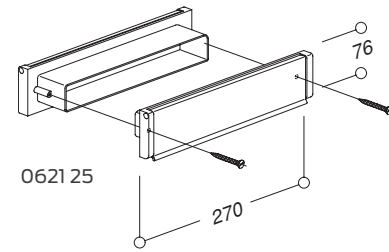

Item Ref:	Description
0621 21	Sprung letterplate 230 x 35mm
0021 21	Sprung letterplate 230 x 35mm
0621 23	Sprung letterplate c/w liner - 254 x 45mm
0021 23	Sprung letterplate c/w liner - 254 x 45mm
0621 25	Sprung letterplate c/w liner and inside tidy - 254 x 45mm
0021 25	Sprung letterplate c/w liner and inside tidy - 254 x 45mm

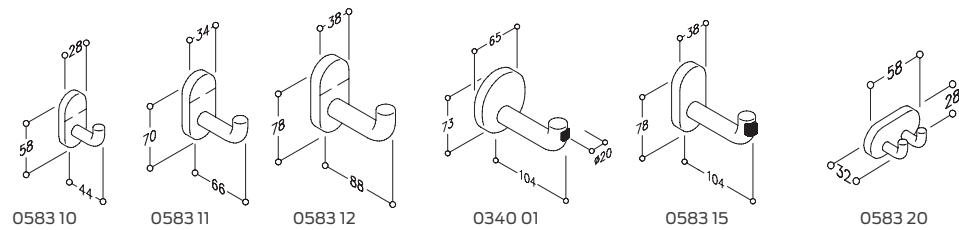

Item Ref:	Description
0583 10	Coat hook 58 x 44 x 28mm
0583 11	Coat hook 70 x 66 x 34mm
0583 12	Coat hook 78 x 88 x 38mm
0340 01	Coat hook with buffer 73 x 104 x 65mm - circular plate
0583 15	Coat hook with buffer 78 x 104 x 38mm
0583 20	Double coat hook 78 x 104 x 38mm - oblong plate

Normbau

Hooks

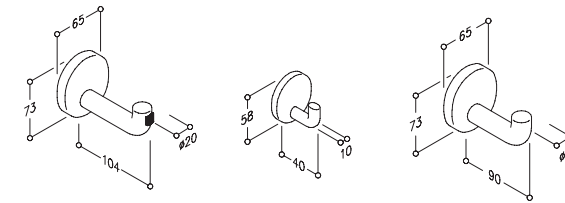

Item Ref:	Description
0304 01	Coat hook with buffer - circular plate 58 x 44 x 28mm
0305 01	Coat hook 10mmØ
0339 01	Coat hook 20mmØ

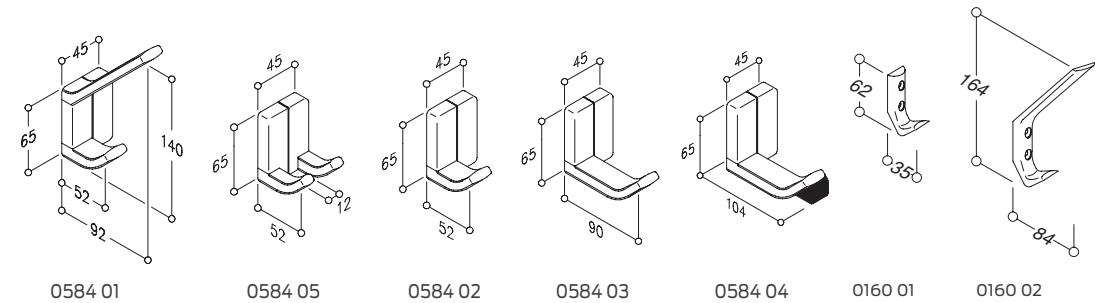

Item Ref:	Description
0584 01	Hat & coat hook 65 x 92 x 45mm
0584 05	Double coat hook 65 x 52 x 45mm
0584 02	Single coat hook 65 x 52 x 45mm
0584 03	Single coat hook 65 x 90 x 45mm
0584 04	Single buffered coat hook 65 x 104 x 45mm
0160 01	Single coat hook 62 x 35mm
0160 02	Hat & coat hook 164 x 84mm

Normbau

Hooks & Bathroom Fittings

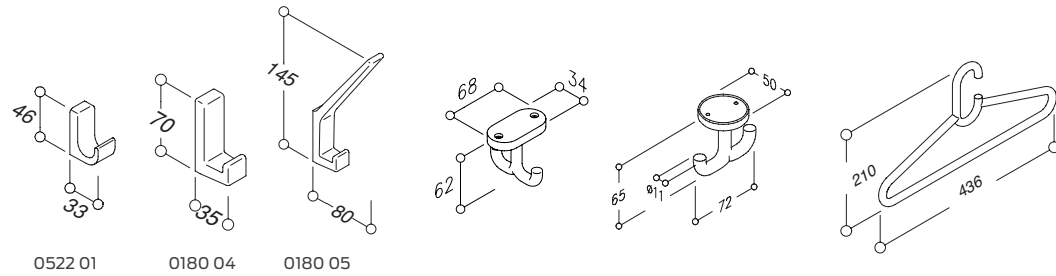

Item Ref:	Description
0522 01	Single coat hook 46 x 33mm
0180 04	Single coat hook 70 x 35mm
0180 05	Hat & coat hook 145 x 80mm
0583 25	Double ceiling mounted hook - 11mmØ x 68mm
0148 02	Double ceiling mounted hook - 11mmØ x 72mm
0338 01	Coat hanger - open
0512 01	Coat hanger - closed



Item Ref:	Description
0399 01	Toilet roll holder
0399 02	Toilet roll holder with anti-theft device
0358 01	Key for 0399 02 anti-theft device
0583 02	Towel/tissue roll holder
0506 01	Towel holder
0518 01	Spare toilet roll holder
0925 40	Toilet brush and wall mounted holder
0925 45	Replacement brush

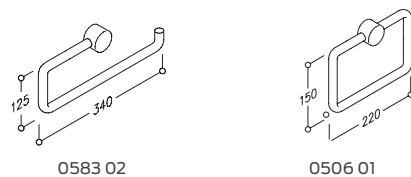

Normbau

Bathroom Fittings

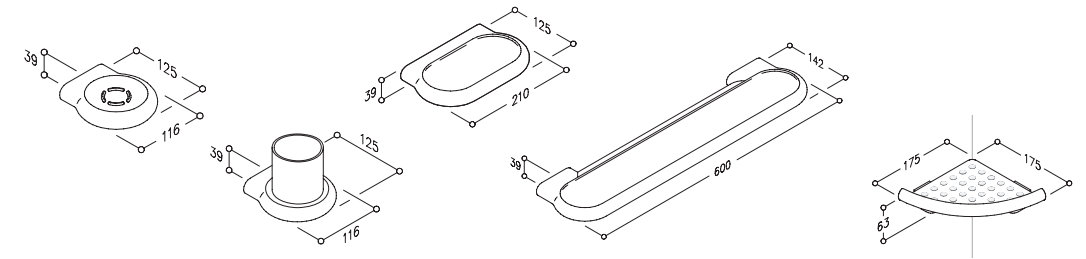

Item Ref:	Description
0925 01	Soap dish with drain hole
0925 02	Soap dish without drain hole
0925 11	Tumbler holder and nylon tumbler
0925 21	Bathroom shelf 125 x 210mm with drain hole
0925 22	Bathroom shelf 125 x 210mm without drain hole
0925 26	Bathroom shelf 1243 x 600mm
0925 33	Corner shelf

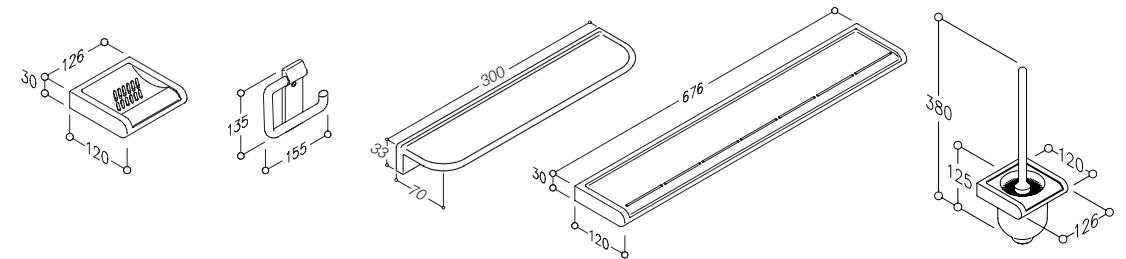

Item Ref:	Description
0824 01	Soap dish with drain hole
0824 02	Soap dish without drain hole
0149 01	Toilet roll holder
0146 01	Bathroom shelf 70 x 300mm
0826 01	Bathroom shelf 120 x 676mm without drain hole
0824 05	Toilet brush with wall mounted holder
0824 06	Replacement brush

Normbau

Bathroom Fittings

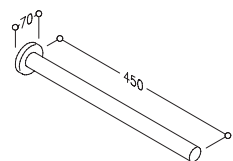

Item Ref:	Description
0436 01	Towel rail - 450mm length - smooth rail
0436 05	Towel rail - 450mm length - textured rail

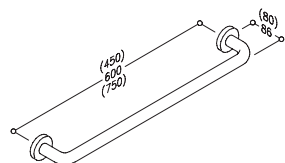

Item Ref:	Description
0528 01	Towel rail - 450mm length - without roses
0528 02	Towel rail - 600mm length - without roses
0528 03	Towel rail - 750mm length - without roses
0528 11	Towel rail - 450mm length - with roses
0528 12	Towel rail - 600mm length - with roses
0528 13	Towel rail - 750mm length - with roses

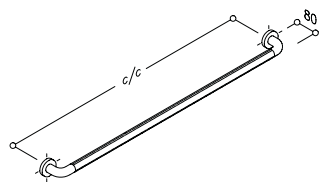

Item Ref:	Description
0453 01	Textured grab rail in sections - 1100mm centres
0453 02	Textured grab rail in sections - 1000mm centres
0453 03	Textured grab rail in sections - 800mm centres

Item Ref:	Description
0453 07	Textured grab rail - single piece moulding - 600mm centres
0453 08	Textured grab rail - single piece moulding - 400mm centres
0453 09	Textured grab rail - single piece moulding - 300mm centres
0453 10	Textured grab rail - single piece moulding - 500mm centres

Item Ref:	Description
0449 12	Rail mounted toilet roll holder - 143 x 120mm



Normbau

Bathroom Fittings



Item Ref:	Description
0447 41	Lift up support rail with padded armrest - Length 600mm
0447 43	Lift up support rail with padded armrest - Length 720mm
0447 45	Lift up support rail with padded armrest - Length 850mm
0447 47	Lift up support rail with padded armrest - Length 900mm

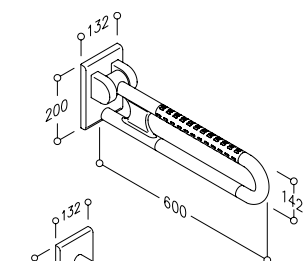

Item Ref:	Description
0447 01	Lift up support rail with textured armrest - Length 600mm
0447 03	Lift up support rail with textured armrest - Length 720mm
0447 05	Lift up support rail with textured armrest - Length 850mm
0447 07	Lift up support rail with textured armrest - Length 900mm

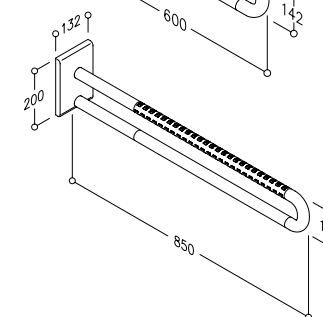

Item Ref:	Description
0467 01	Fixed support rail with textured armrest - Length 600mm
0467 03	Fixed support rail with textured armrest - Length 725mm
0467 05	Fixed support rail with textured armrest - Length 850mm

Normbau

Bathroom Fittings

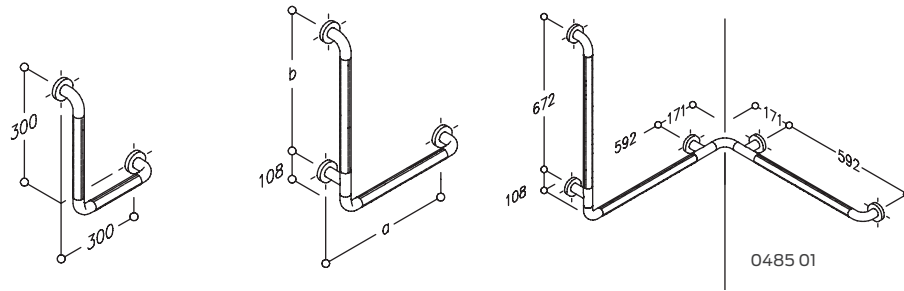

Item Ref:	Description
0464 01	Textured grab rail - 300 x 620mm
0464 02	Textured grab rail - 300 x 300mm
0464 03	Textured grab rail - 400 x 750mm centres (a / b)
0464 04	Textured grab rail - 500 x 620mm centres (a / b)
0464 05	Textured grab rail - 500 x 750mm centres (a / b)
0485 01	Corner shower hand rail

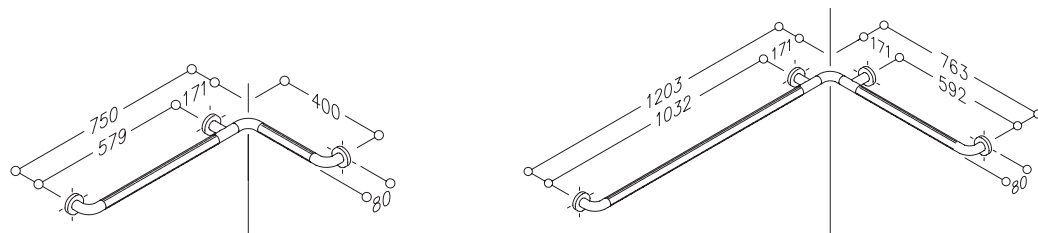

Item Ref:	Description
0483 01	Textured grab rail - Corner rail 763 x 763mm
0483 03	Textured grab rail - Corner rail 400 x 750mm
0483 02	Textured grab rail - Corner rail 763 x 1203mm

Normbau

Bathroom Fittings

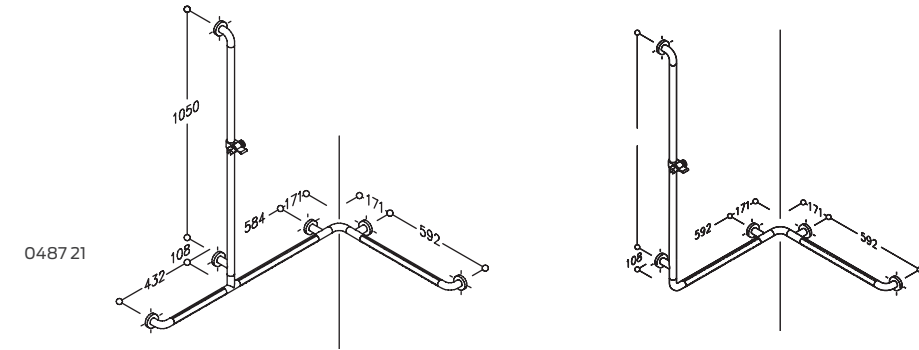

Item Ref:	Description
0487 04	Corner shower head rail - reversible
0487 21	Corner shower head rail - 763 x 763 x 1158mm
0486 03	Corner shower head rail - 860mm high
0486 04	Corner shower head rail - 1158mm high
0486 051	Corner shower head rail - 750mm high
0486 052	Corner shower head rail - 1100mm high

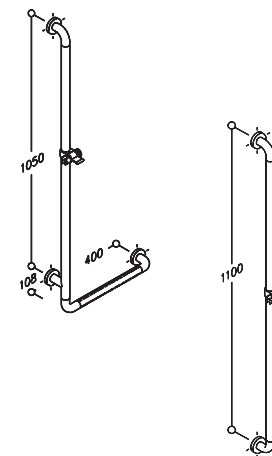

Item Ref:	Description
0465 04	Shower head rail - 400 x 1158mm
0465 05	Shower head rail - 500 x 1158mm
0465 051	Shower head rail - 500 x 750mm
0465 052	Shower head rail - 500 x 1000mm
0488 03	Straight shower head rail - 1100mm centres
0488 05	Straight shower head rail - 1000mm centres
0488 07	Straight shower head rail - 800mm centres
0488 09	Straight shower head rail - 600mm centres

Normbau

Bathroom Fittings

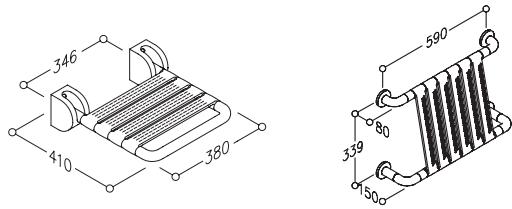

Item Ref:	Description
0841 01	Lift up shower seat - wall mounted
0841 32	Backrest - wall mounted

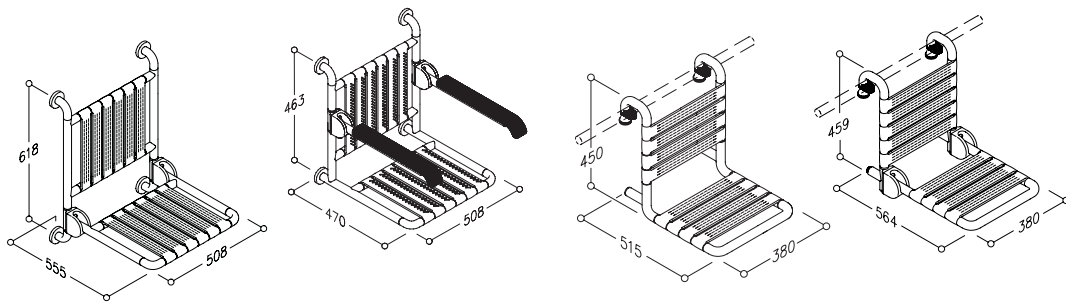

Item Ref:	Description
0841 11	Lift up shower seat with backrest - wall mounted
0841 24	Fixed shower seat with lift up padded armrests - wall mounted
0847 01	Rail mounted/suspended shower seat with backrest
0847 11	Rail mounted/suspended shower seat with backrest and lift up seat

Normbau

Bathroom Fittings

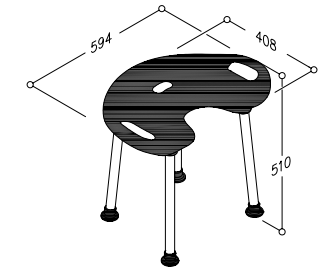
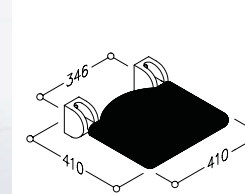

Item Ref:	Description
0844 011	Lift up padded shower seat - wall mounted - Grey
0300 345	Freestanding shower stool with padded seat - Black
0300 346	Freestanding shower stool with padded seat - Grey

## Scope of Access Control

Controlling access is vital if the security of buildings is not to be compromised. In buildings where there are a variety of users with different areas of responsibility and different security priorities, masterkeyed systems for cylinder locks have traditionally provided the simplest, and most cost effective way of managing controlled access to facilities.

There are however, a number of alternative ways of providing controlled access depending on the level of security required, the degree of convenience, the budget available and the possible need for future expansion of the system. All these aspects need to be considered before selecting the most appropriate solution.

For many situations the use of a cylinder lock may not be the ideal solution to the security requirements of a specific door. The reasons can be many and varied. A door which is required to be kept locked whilst allowing 'keyholders' access can be inconvenient if the door is in constant use or if the number of users is very high. Similarly, a high turnover of users can become a nuisance if keys are not returned and the cylinder has to be constantly replaced to maintain security.

There are many levels of access control from mechanical digital locks and simple off-line battery powered electronic locks, through wireless electronic locks using proximity card technology to full on-line integrated access control systems.

Allegion is able to offer access control products at all levels, however here we have concentrated on the most common trade products.

At the other end of the scale a high degree of control may be required allowing the building or facility owner to more closely control or monitor who accesses the door. Such increased control could include determining not only who has access, but at what times and for how long. In such circumstances electromechanical or electronic access control systems provide a more appropriate solution.

4  
Facility  
integration

3  
Networked access  
control & biometrics

2  
Electronic access control & key management

1  
Mechanical access/egress control

If you require further guidance on access control, or for information on Allegion's ranges of electronic access control or biometric access control please call our technical helpline on 0800 834102 or go to [www.allegion.co.uk](http://www.allegion.co.uk)

## Briton 9160

## Mechanical Push Button Code Lock



### General Description

A simple means of securing a door which requires restricted but convenient access such as an office, workshop or storeroom.

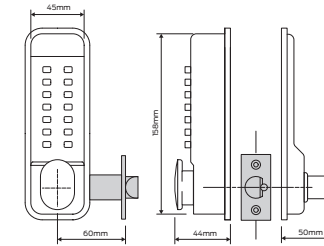

### Principal Features

- Digital deadlocking mortice latch
- Easy to fit
- Doors unlocked simply by entering a pre-set code
- Codes changed quickly and easily
- Optional hold-open function (non-hold open can be engaged easily, if required)
- Suitable for light duty and internal use
- Spindle can be cut on site to suit doors 30-60mm thick
- Guarantee: 5 years



Item Ref:	Description	Finishes
9160	Mechanical digital lock c/w hold back function (Boxed)	PB; SV
P9160	Mechanical digital lock c/w hold back function (Pre Pack)	PB; SV

## Briton 9260

## Mechanical Push Button Code Lock



### General Description

A simple means of securing a door which requires restricted but convenient access.

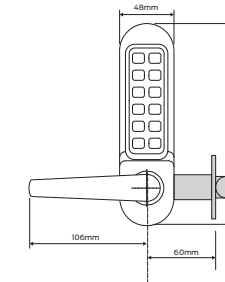

### Principal Features

- Digital code lock with over 2047 non sequential code options
- Available with extra long spindles for use with Briton exit devices
- Lever operation with clutch mechanism
- Code changed by removing the unit from the door
- Available in satin or polished stainless steel, or polished brass
- Guarantee: 5 years



Item Ref:	Description	Finishes
9260	Mechanical digital lock c/w hold back function (Boxed)	PVD-SS

Briton 9360

Electronic Digital Code Lock

General Description

A simple means of upgrading an existing mechanical digital code lock, or for new installations.

Principal Features

- Uses the same fixing holes as many common mechanical code locks
- Simple and quick replacement for upgrading a mechanical code lock to an electronic digital code lock
- Does not require the unit to be removed to change codes
- Up to 80 user codes of 4 to 6 digits
- Up to 10 'One Time' user codes
- Over 80,000 operations from 2 x AA batteries (supplied with product)
- External battery override contacts
- Key override as standard
- Supplied with tubular mortice latch
- Non handed
- Guarantee: 5 years



Finishes

Available in PVD brushed steel.



Inside unit

Outside unit

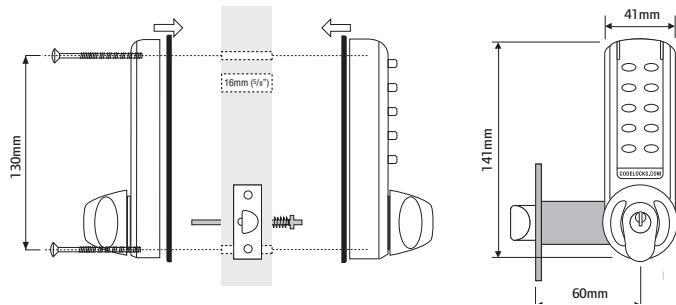

Item Ref:	Description	Finishes
9360	Electronic digital lock	PVD - BS

Briton 9500 Series

Electromagnetic Locks

The Briton 9500 Series is a high quality range of 'face to face' locking devices offering up to 545kg holding force. The range includes small footprint 'mini-mags' for lower security applications and a mortice mounted version for use with custom made architectural housings for single or double door applications.

As standard, 9500 Series electromagnets are suitable for outswing doors but can be converted for use on inswing doors using a series of Z and L brackets.



Principal Features

- Extruded aluminium housing with adjustable mounting bracket for quick and simple installation
- Suitable for single swing doors
- All units are "fail unlocked" providing safe exit in the event of power failure or an emergency when interfaced to a fire alarm output
- Monitored and unmonitored versions where indicated
- Door status monitor (DSM) indicates when a door is open or closed when monitored remotely
- Steel armature is fixed through the door for a secure mounting
- Mortice version is designed for installation into architectural housings, either horizontal or vertical
- Testing: CE marked to EN61000 for Electromagnetic compatibility Directive 2014/30/EU
- Guarantee: 3 years



Installation options

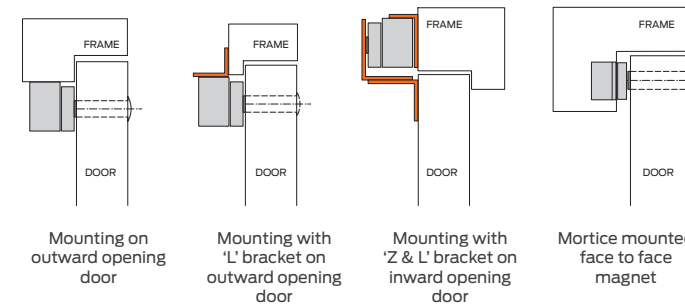

Technical Specification

- Voltage - 12v or 24v DC (all models)
- Current draw  
9501/9502/9551/9552  
500mA @ 12v DC  
250mA @ 24v DC
- Current draw 9560  
480mA @ 12v DC  
240mA @ 24v DC
- Holding forces  
272kg per leaf (9551/9552)  
544kg per leaf (9501/9502)  
272kg per leaf (9560)

Briton 9500 Series

Electromagnetic Locks



9501



9502



9551



9552



9560

Item Ref:	Description	Holding Force	Dimensions (h x l x d)
9551	Single face to face Mini Magnet - unmonitored	272 kg	42 x 250 x 25mm
9551.M	Single face to face Mini Magnet - monitored	272 kg	42 x 250 x 25mm
9552	Double face to face Mini Magnet - unmonitored	272 kg per leaf	42 x 500 x 25mm
9552.M	Double face to face Mini Magnet - monitored	272 kg per leaf	42 x 500 x 25mm
9501	Standard face to face single magnet - unmonitored	544 kg	73 x 266 x 40mm
9501.M	Standard face to face single magnet - monitored	544 kg	73 x 266 x 40mm
9502	Standard face to face double magnet - unmonitored	544 kg per leaf	73 x 532 x 40mm
9502.M	Standard face to face double magnet - monitored	544 kg per leaf	73 x 532 x 40mm
9560	Mortice mounted single magnet - unmonitored	272 kg	Magnet - 37.5 x 228 x 26 Armature - 37.5 x 186 x 12mm
9560.MBS	Mortice mounted single magnet - monitored	272 kg	

Briton 9500 Series

Accessories



General Description

A series of extruded aluminium brackets for use with surface mounted face to face magnets. Refer to Installation Options on page 157.

Item Ref:	Description	Finish
9501.L	L bracket for use with 9501/9502 magnets	SV
9501.ZL	Z & L bracket set for use with 9501/9502 magnets on inward opening doors	SV
9551.L	L bracket for use with 9551/9552 magnets	SV
9551.ZL	Z & L bracket set for use with 9551/9552 magnets on inward opening doors	SV

Briton

Access Control Accessories

General Description

Additional items to complete an access control system.



ACCBS1



ACMBS1

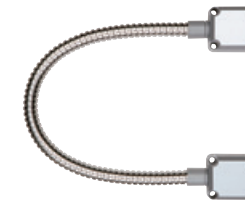

ACDL9



PSTL2

Item Ref:	Description	Finish
ACCBS1	Exit push button - flush mounted with green plastic domed button - stainless steel	SS
ACMBS1	Exit push button - flush mounted vandal resistant - stainless steel	SS
ACDL9	Door loop for power transfer - surface mounted	SV
PSTL2	Power supply unit 12v DC - 1 Amp	-





## Briton

## Freestanding Display Units

To help our retailers in displaying and selling out our products we have developed a range of merchandising units designed to provide flexible display options in store.

Research has shown that by displaying ironmongery products better in store and providing selection tools to assist purchasers with their product choice, sales of these products are significantly increased.

Currently of all the fire doors sold out of UK builders merchants less than 20% include the corresponding sales of fire door ironmongery. However by placing an ironmongery merchandising unit adjacent to the fire doors this figure can be significantly increased.

In this section we highlight units as well as details of other point of sale and selection tools to help you in maximising your ironmongery sales.

## Principal Features

- Designed to provide flexible display space in store
- Ideal for gondola ends or sighting next to fire doors or trade counters
- Low height ensures that good visibility throughout store is maintained
- Supplied complete with Selection Guides for Briton Door Closers and Exit devices to help customers to choose the product they need for their particular application
- Designed to display a core range of Briton door closers, exit devices and commercial locks suitable for use on fire doors
- Incorporates literature holders for displaying Briton literature

**To place an order for these units please contact your Key Account Manager or call our marketing department on 0121 380 2454 for more information.**

Briton

Display Boards & Lock Blocks

General Description

For instances where it is not possible to have stock on display we are able to provide product display boards and lock blocks.



Bespoke Display Units

If your display requirements do not suit our standard display units we are willing to work with you in developing bespoke units to meet your exact requirements.

**Please contact your Key Account Manager to discuss your requirements in more detail.**



www.allegion.co.uk

Briton

Product Selectors, Posters & Counter Mats



Principal Features

- Designed to help customers in selecting the right product for their particular application depending on the type of door, its location and its usage
- Providing guidelines on CE marking and the latest European standards they help to ensure their product choice meets with the latest building regulations

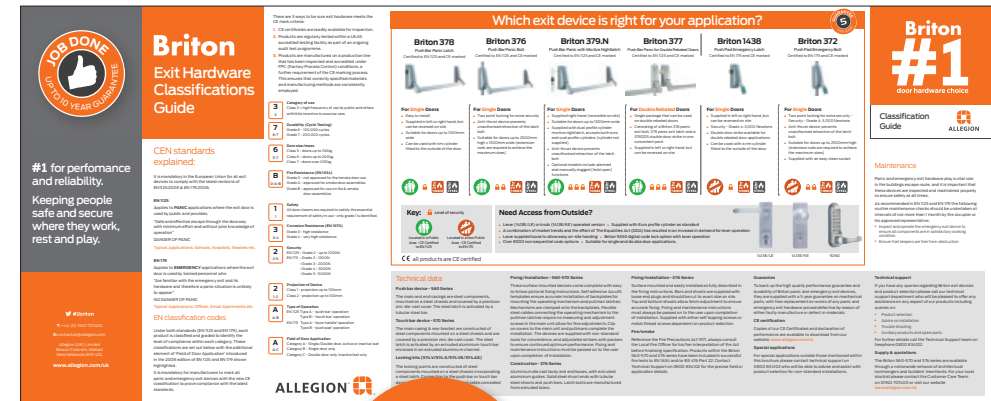

Don't forget to pick up your fully certified  
**Briton**  
door hardware  
✓ Door Closers ✓ Door Furniture  
✓ Exit Hardware ✓ Cylinders  
✓ Lockcases ✓ Hinges

I'M A  
**Briton**  
#1 door hardware  
INSTALLER

We stock  
**Briton**  
#1 door hardware  
choice

**ADDITIONAL POINT OF SALE**  
If you have any specific POS requirements outside of what we have detailed here please contact our marketing department on **0121 380 2454** or email **contactuk@allegion.com**

**Anti-Drill Plate**

Steel plate with sufficient hardness to resist penetration by a HSS drill bit

**Anti-Thrust Action**

Latch action in which the latch bolt, when fully thrown, resists being forced back by end pressure

**Anti-Thrust Bolt**

Spring actuated bolt which cannot be pushed back once it has been fully thrown into a correctly positioned locking plate

**ASTM**

An International voluntary standards development organisation

**Backcheck**

A 'cushioning' effect to prevent damage to door and adjoining structure if door is thrown or blown open

**Backplate**

Separate component on back of product providing the fixing means

**Backset**

Distance from the outer face of the forend (or faceplate if fitted) to the centre-line of the keyhole and/or follower

**Bathroom Lock**

Privacy lock with latch bolt operated by lever handle or knob from both sides, and an additional deadbolt operated by thumb slide, thumb turn etc, from inside only

**BKP**

Special patented device which prevents the cylinder from being bumped

**Bolt**

Moving part of a lock or latch that provides engagement between leaf and frame

**Bolt Through Fixing**

Method of installation whereby the fixing means pass right through the door

**Bumping**

Where cylinders are bumped, leaving no sign of forcible entry

**CE**

CE marking is a mandatory European marking for certain product groups to indicate conformity with the essential health and safety requirements set out in European Directives

**Certifire**

Is an independent third party product certification at a higher level, a quality mark, designed to enable manufacturers to demonstrate a difference between their products and those satisfying only the minimum requirement

**Classroom Function**

The classroom function in a thumb-turn cylinder makes it possible to rotate the thumb-turn in one direction only. This is usually used to ensure that someone inside a room cannot lock anybody out but can always escape in an emergency. The cylinder is also clutch release so somebody in the room cannot prevent a key holder from entering

**Closing Speed**

Speed at which a door leaf is allowed to close when under hydraulic control

**Deadbolt**

Bolt that can be deadlocked

**Delayed Action**

Inbuilt function of any door closing device that allows the closing moment to be adjusted

**Differs**

Refers to the key arrangement of a lock, with the higher the number of differs providing the greater key security

**Dogging**

A device found on exit hardware. If an exit door permits unrestricted traffic flow, a dogging device is a means of holding back the latch bolts when required

**Door Closer Power Size**

Usually determined by size and weight of door

**Drill Resistance**

Cylinders that have one or more steel components in the cylinder which are designed to resist or delay attacks from a drill

**EN**

European Normative Standards Agency

**Electromagnetic Hold Open**

A closer with an integral electro magnet allows a fire door to be held open for convenience. The magnet is linked into the fire alarm system and automatically releases the door when the fire alarm is activated

**Electromagnetic Swing Free**

As electromagnetic hold open, but permits a fire door to be 'free swinging' for convenience. Not recommended for general traffic areas

**Escutcheon**

Component which surrounds the entrance to a keyhole at the surface of the leaf, for decorative purposes

**Euro profile Cylinder/DIN Cylinder**

Profile cylinder for which the cross-section of the housing is to the standard European profile

**Exit Device**

Device that provides an emergency or panic exit function of an escape route

**Handed**

Restricted to one particular closing or opening direction

**IP rating**

This is the degree to which an item is protected from the environment

**Keyed Alike**

Operable with the same key

**Latch Action**

Self-engaging fastener which secures the leaf of a door in the closed position, and which can be released by hand

**Master Keyed**

Key that operates locks of all combinations in a suite

**Nightlatch**

Lock with automatic bolt which is withdrawn from outside by key, and from inside by handle or knob

**Non-Handed**

Not restricted to one particular closing or opening direction

**Outside Access Device (OAD)**

Mechanism for opening exit device from outside

**Panic Latch**

Latch which is released by pressure anywhere along a horizontal bar running the width of the door

**Pick Resistance**

Special configuration of hardened pins and drivers within a cylinder to resist attack by specialist picking tools

**Push Resistant**

A cam that protrudes from the cylinder body to anchor firmly to the lock preventing it from being dislodged by a hammer blow

**Part M**

Building regulations Part M 2004 Access to and Use of Buildings

**Pullman Latch**

Panic Exit latch with curved bearing surfaces to facilitate engagement and release under side load

**Push Bar**

Horizontal bar of a panic exit device which is used to activate the mechanism

**Push Pad**

An accepted operating elements of an emergency exit device

**Rim Cylinder**

Cylinder for use with a rim lock or latch, which is adapted for flush mounting with a leaf

**Rim Deadlock/Latch/Rim Lock/Night latch**

Adapted for surface mounting on the face of a leaf

**Snap Resistant**

Patented laminated steel core that provides snap resistance to both flexural and pulling test

**Sprung**

Hardware containing a spring mechanism which enables the door handle to return to the horizontal position after use

**Template Adjustable**

Door closer strength determined by fixing position

**Thumb Turn**

Small handle or knob for operating by thumb and forefinger

**Track Arm**

A single arm which avoids the need for projecting arm

**Tri-packed**

Offer various fixing positions ie regular, transom & parallel

**Vandalgard**

Clutching mechanism designed to guard against user abuse

**Windthrough Adjustable**

Door closer strength determined by physical windthrough adjustment of the closer spring

The hardware products detailed within this catalogue are available in a wide selection of finishes including:

- Solid metallic finishes
- Electroplated metallic finishes
- Powder coated metallic finishes
- Powder coated coloured finishes

**Due to the limitations of the printing process it is advisable to check your choice of finish against actual product.**

**Solid metallic finishes**

The solid metal finishes are polished finishes on stainless steel, aluminium or brass. The final finish is either a satin or bright mirror polished finish. Aluminium finishes are then anodised, brass finishes are protected with a lacquer unless indicated otherwise.

**Plated metallic finishes**

Products and components which are manufactured in other materials may be given metallic plated finish either for corrosion protection or to match other related items. For example, some items may be manufactured in brass or steel but have a satin chrome or satin nickel plated finish to integrate with satin stainless steel finishes.

**Powder coated metallic finishes**

A large range of items are available in a metallic powder coated finish which provides a consistent finish across a range of products manufactured in different materials. They provide good corrosion resistance, particularly suitable for items which are used externally.

**Powder coated coloured finishes**

The powder coated coloured finishes are specially formulated to provide a close match to the coloured nylon finishes of our Normbau range of door hardware.

**Product variations**

**Door Controls**

All door controls, whether projecting, parallel or track arm variants, are supplied with arms, brackets and/or tracks finished to match the body cover. In these situations the finish is quoted with a suffix S. For example, a closer in SE (powder coated silver) finish which has matching arms/brackets is specified as SES finish.

Black arm sets only available for 996 Series.



Briton

Finishes

**Solid Metallic and Plated Finishes**

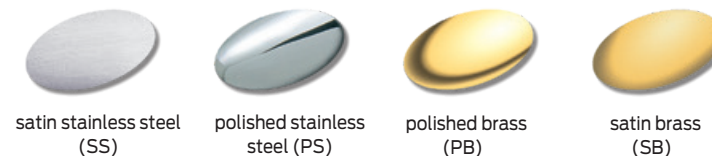

**Powder Coated Metallic Finishes**

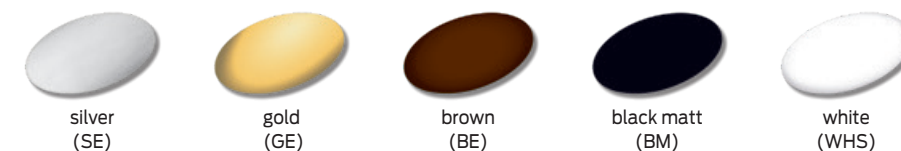

**Powder Coated Coloured & Normbau Nylon Finishes**



Please Note: slate blue 63 is not available on push plates.





Cl/Sfo	(31.59)	X	
Uniclass	L4181		

March 2020

## About Allegion

Allegion (NYSE: ALLE) is a global pioneer in seamless access, with leading brands like CISA®, Interflex®, LCN®, Schlage®, SimonsVoss® and Von Duprin®. Focusing on security around the door and adjacent areas, Allegion secures people and assets with a range of solutions for homes, businesses, schools and institutions. Allegion had \$2.9 billion in revenue in 2019, and sells products in almost 130 countries.

For more, visit [allegion.co.uk](http://allegion.co.uk)

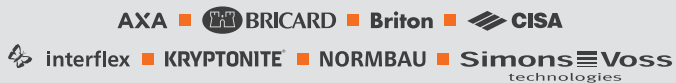

Allegion (UK) Limited

35 Rocky Lane  
Aston  
Birmingham  
B6 5RQ

Tel: +44 (0) 330 8080 617  
Email: [contactuk@allegion.com](mailto:contactuk@allegion.com)  
Web: [allegion.co.uk](http://allegion.co.uk)

